

SECTION 20. ELECTRICAL AND ELECTRONIC SYMBOLS

11-271. GENERAL. The electrical and electronic symbols shown here are those that are likely to be encountered by the aviation maintenance technician. They are in accordance with ANSI-Y32.2-1975.

11-272. SYMBOLS. Only those symbols associated with aircraft electrical and electronic wiring have been listed in general. Refer to ANSI-Y32.2-1975 for more specific detail on each symbol.

TABLE 11-27. Electronic/Electrical Symbols.









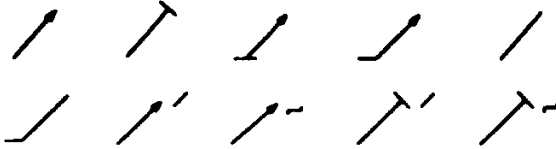

Symbol	Meaning
	Adjustability Variability
	Radiation Indicators
	Physical State Recognition
	Test-Point Recognition
	Polarity Markings
	Direction of Flow of Power, Signal, or Information
	Kind of Current
	Envelope Enclosure
	Shield Shielding
	Special Connector or Cable Indicator

TABLE 11-27. Electronic/Electrical Symbols (continued).





Symbol	Meaning
	Resistor
	Capacitor
	Antenna
	Battery
	Thermal Element Thermomechanical Transducer
	Thermocouple
	Spark Gap Ignitor Gap
	Continuous Loop Fire Detector (Temperature Sensor)
	Ignitor Plug

TABLE 11-27. Electronic/Electrical Symbols (continued).

Symbol	Meaning
	<p>Transmission Patch Conductor Cable Wiring</p>
<p style="text-align: center;">F S T V</p>	<p>Distribution Lines Transmission Lines</p>
	<p>Alternative or Conditioned Wiring</p>
	<p>Associated or Future</p>

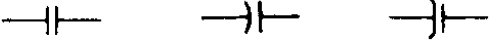
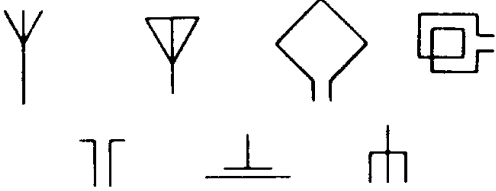
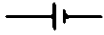
TABLE 11-27. Electronic/Electrical Symbols (continued).



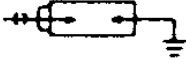

Symbol	Meaning
	Intentional Isolation of Direct-Current Path in Coaxial or Waveguide Applications
	Waveguide
	Strip-Type Transmission Line
	Termination
	Circuit Return
	Pressure-Tight Bulkhead Cable Gland Cable Sealing End
	Switching Function
	Electrical Contact

TABLE 11-27. Electronic/Electrical Symbols (continued).

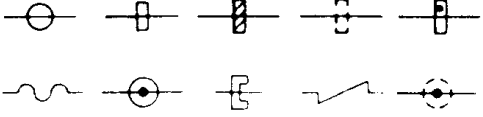
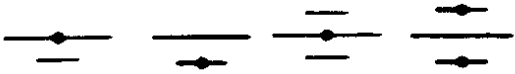

Symbol	Meaning
	<p>Basic Contact Assemblies</p>
	<p>Magnetic Blowout Coil</p>
	<p>Operating Coil Relay Coil</p>
	<p>Switch</p>
	<p>Pushbutton, Momentary, or Spring-Return</p>

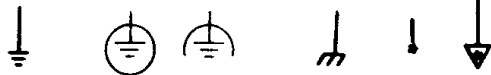
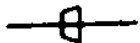
TABLE 11-27. Electronic/Electrical Symbols (continued).

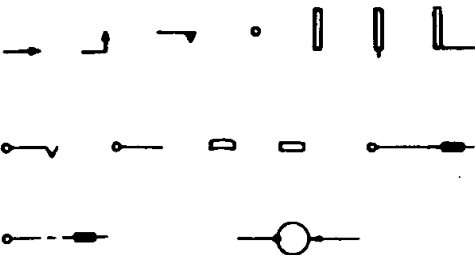

Symbol	Meaning
	<p>Two-Circuit, Maintained, or Not Spring-Return</p>
	<p>Nonlocking Switching, Momentary, or Spring-Return</p>
	<p>Locking Switch</p>
	<p>Combination Locking and Nonlocking Switch</p>
	<p>Key-Type Switch Lever Switch</p>

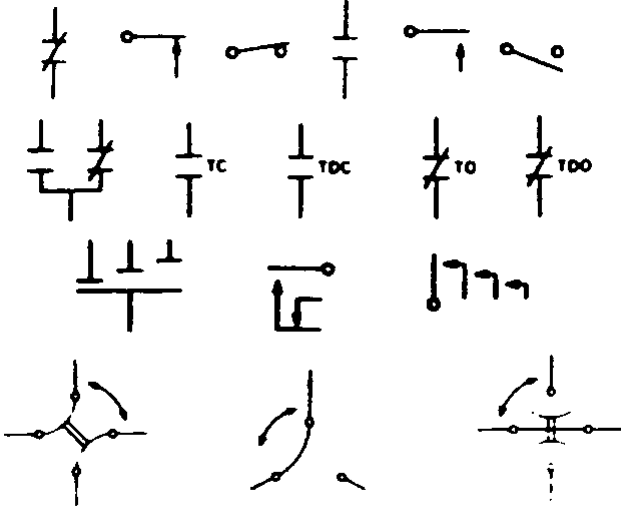
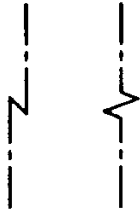
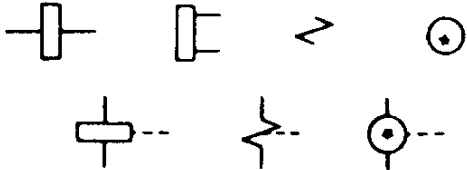
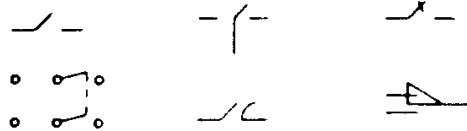
TABLE 11-27. Electronic/Electrical Symbols (continued).



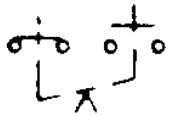
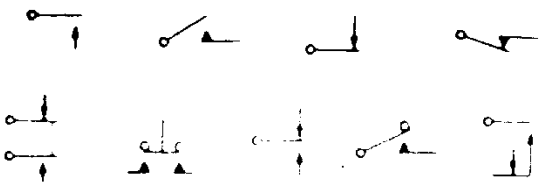
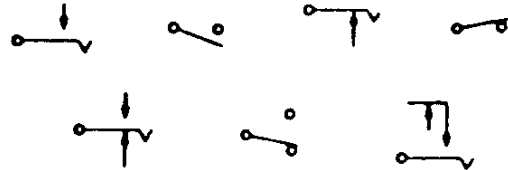

Symbol	Meaning
	<p>Selector or Multiposition Switch</p>
	<p>Safety Interlock</p>
	<p>Limit Switch Sensitive Switch</p>
	<p>Switches with Time-Delay Feature</p>
	<p>Flow-Actuated Switch</p>

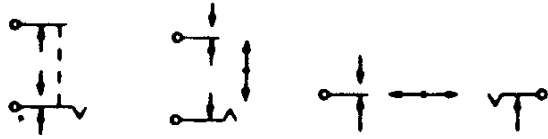
TABLE 11-27. Electronic/Electrical Symbols (continued).



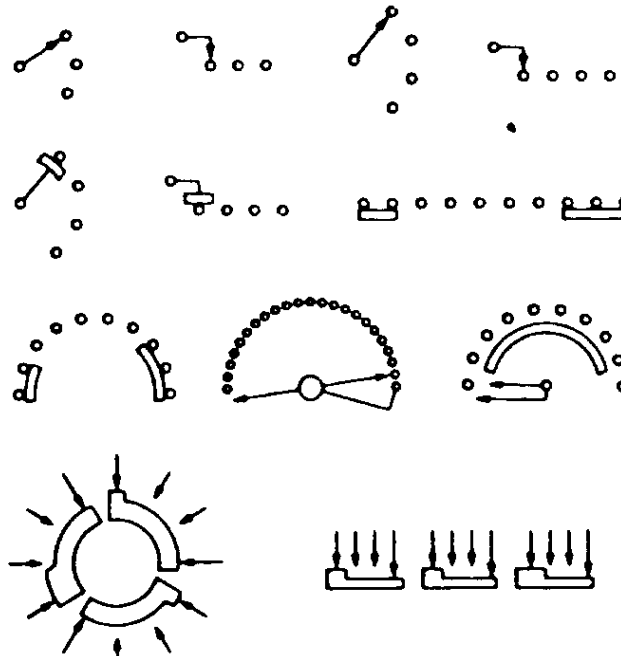

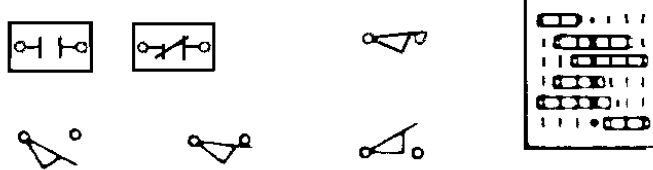
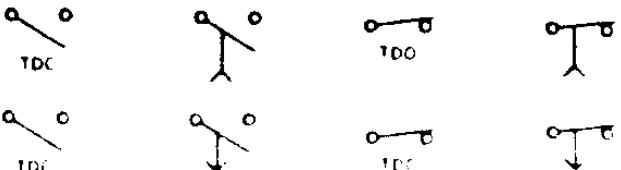

Symbol	Meaning
	Liquid-Level Actuated Switch
	Pressure- or Vacuum-Actuated Switch
	Temperature-Actuated Switch
	Thermostat
	Flasher Self-Interrupting Switch
	Foot-Operated Switch Foot Switch
	Switch Operated by Shaft Rotation and Responsive to Speed or Direction
	Switches with Specific Features

TABLE 11-27. Electronic/Electrical Symbols (continued).







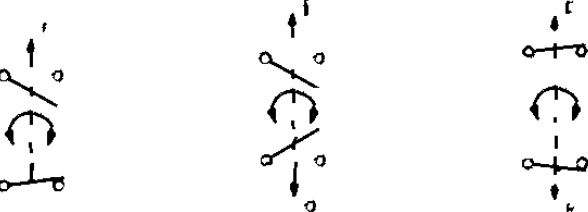
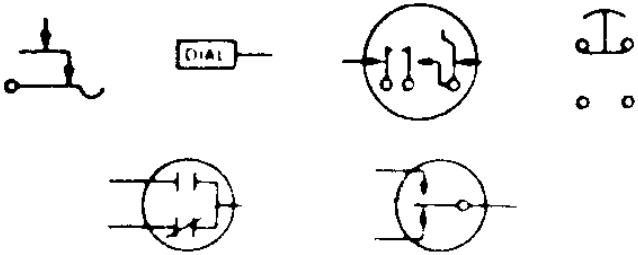





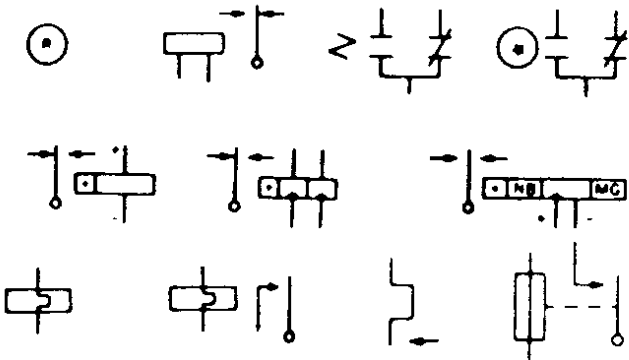

Symbol	Meaning																				
	<p>Governor Speed Regulator</p>																				
<table border="0"> <tr> <td> AC</td> <td>D</td> <td>DP</td> <td>MG</td> </tr> <tr> <td> P</td> <td>DB</td> <td>EP</td> <td>NB</td> </tr> <tr> <td> SO</td> <td>SA</td> <td>SW</td> <td>NR</td> </tr> <tr> <td> SR</td> <td>L</td> <td>ML</td> <td>FO</td> </tr> <tr> <td></td> <td></td> <td></td> <td>FR</td> </tr> </table> 	 AC	D	DP	MG	 P	DB	EP	NB	 SO	SA	SW	NR	 SR	L	ML	FO				FR	<p>Relay</p>
 AC	D	DP	MG																		
 P	DB	EP	NB																		
 SO	SA	SW	NR																		
 SR	L	ML	FO																		
			FR																		
	<p>Inertia Switch</p>																				
	<p>Mercur Switch</p>																				
	<p>Terminals</p>																				

TABLE 11-27. Electronic/Electrical Symbols (continued).



Symbol	Meaning
	Cable Termination
	Connector Disconnecting Device
	Connectors of the Type Commonly Used for Power-Supply Purposes
	Test Blocks
	Coaxial Connector
	Waveguide Flanges Waveguide Junction

TABLE 11-27. Electronic/Electrical Symbols (continued).

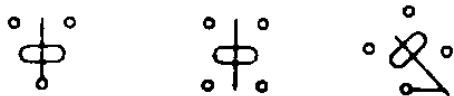
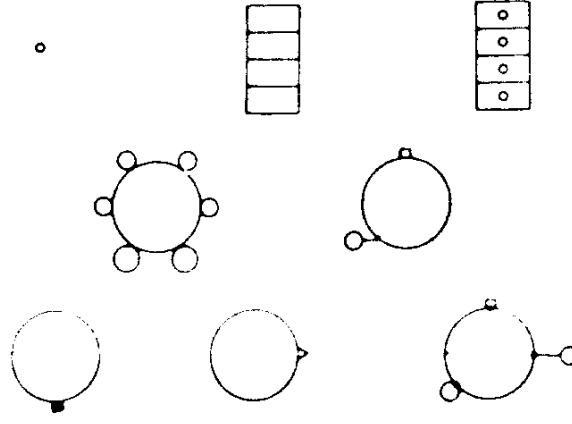

Symbol	Meaning
	Fuse
	Lightning Arrester Arrester Gap
	Circuit Breaker
	Protective Relay
	Audible-Signaling Device
	Microphone

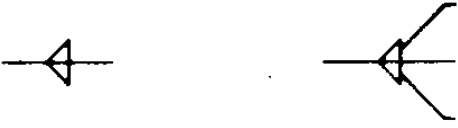
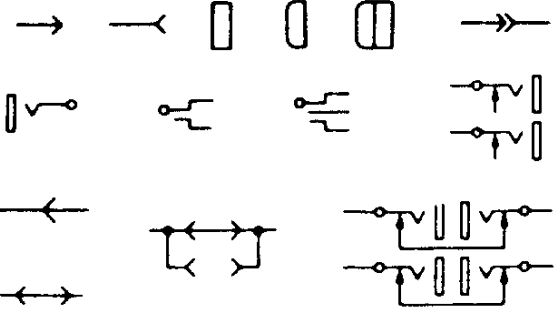
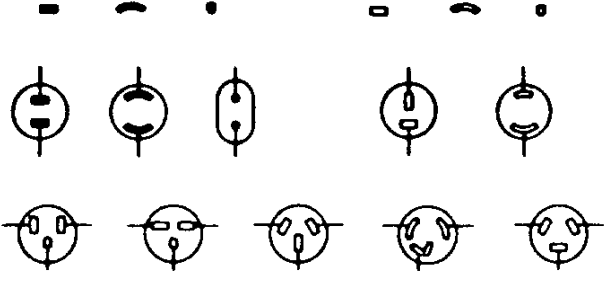
TABLE 11-27. Electronic/Electrical Symbols (continued).

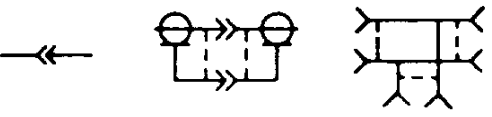
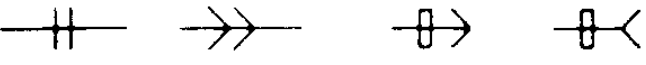



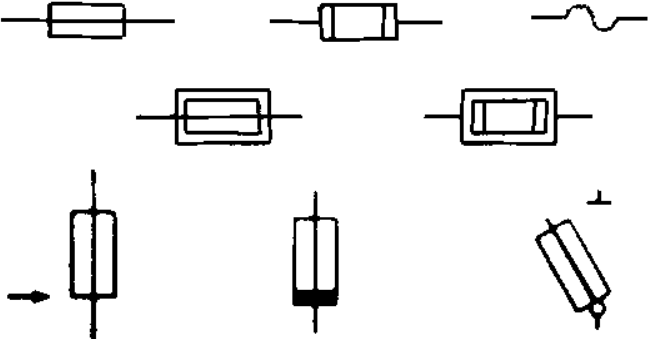
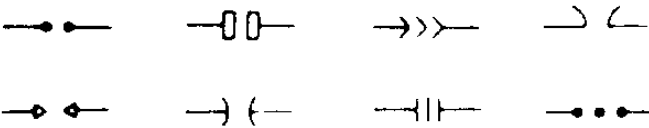
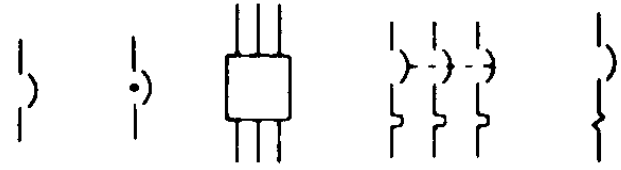
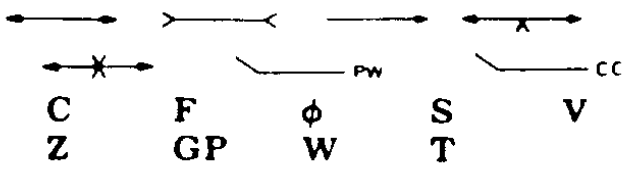
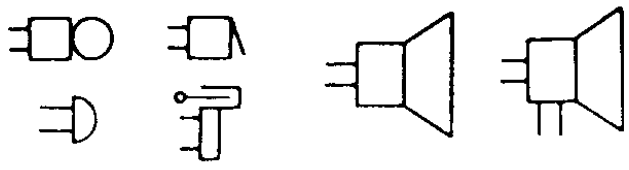

Symbol	Meaning
	<p>Handset Operator's Set</p>
	<p>Lamp</p>
	<p>Visual-Signaling Device</p>
	<p>Mechanical Connection Mechanical Interlock</p>
	<p>Mechanical Motion</p>
	<p>Clutch Brake</p>

TABLE 11-27. Electronic/Electrical Symbols (continued).

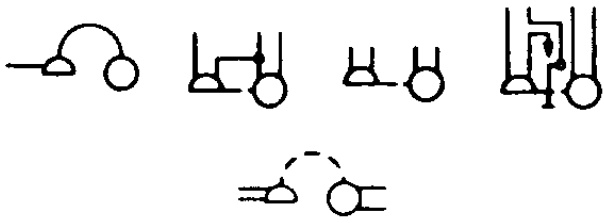
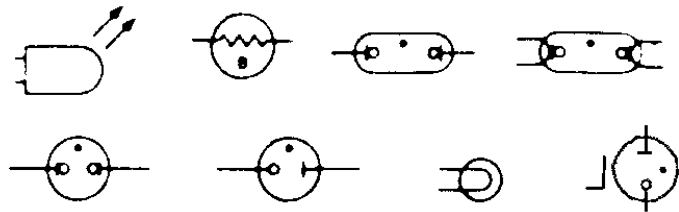
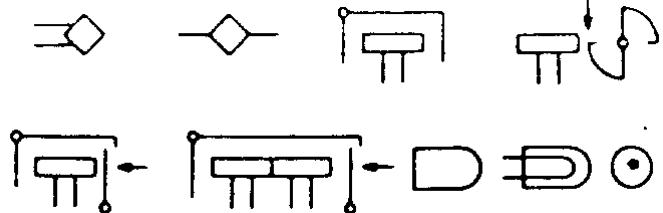
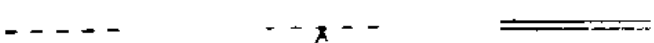
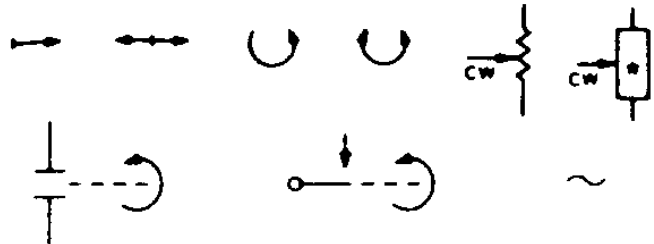
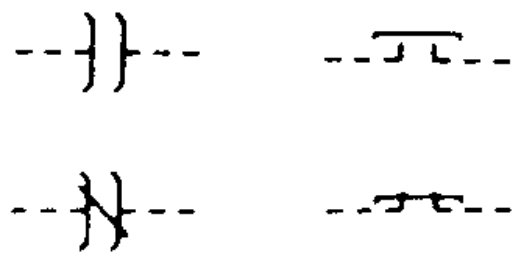
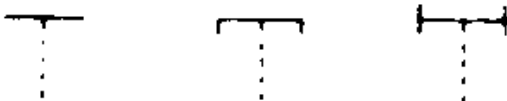
Symbol	Meaning
	Manual Control
	Gyro Gyroscope Gyrocompass
	Position Indicator
	Fire Extinguisher Actuator Head
	Position Transmitter
	Radio Station
	Space Station

	<p>Integrated Circuit</p>
 <p>GENERAL SYMBOLS MAGNETIC AMPLIFIER</p>	<p>Amplifiers</p>
 <p>INVERTOR OR NOT GATE</p> <p>AND GATE WITH THREE INPUTS NAND (NOT AND) GATE</p> <p>OR GATE NOR (NOT OR) GATE</p> <p>EXCLUSIVE OR GATE</p>	<p>Logic Gates</p>
	<p>Diode</p>
 <p>EMITTER BASE COLLECTOR</p> <p>EMITTER BASE COLLECTOR</p>	<p>Transistor Symbols</p>

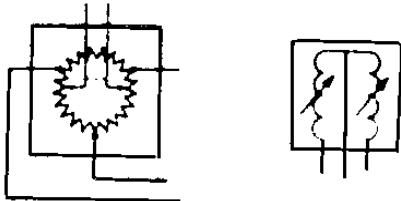
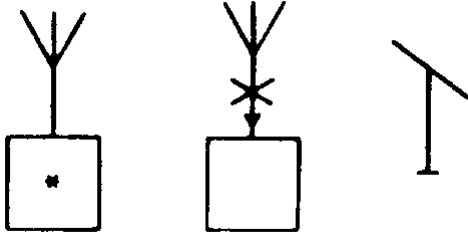
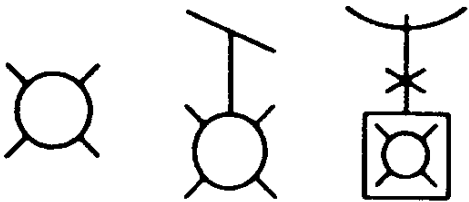
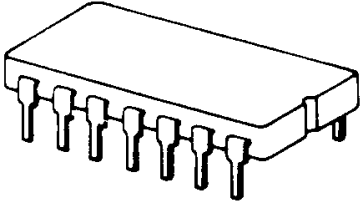
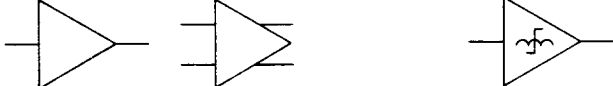
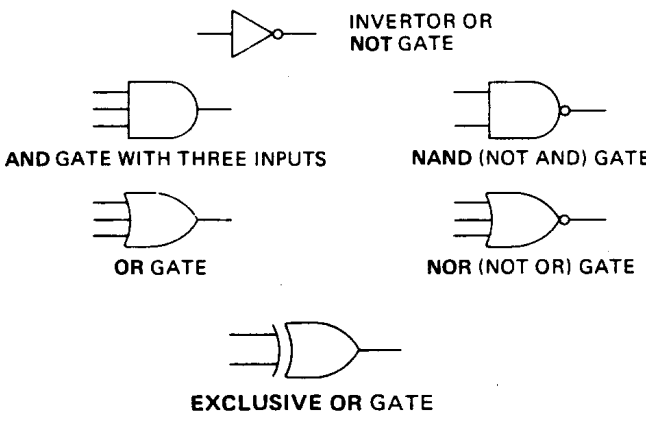
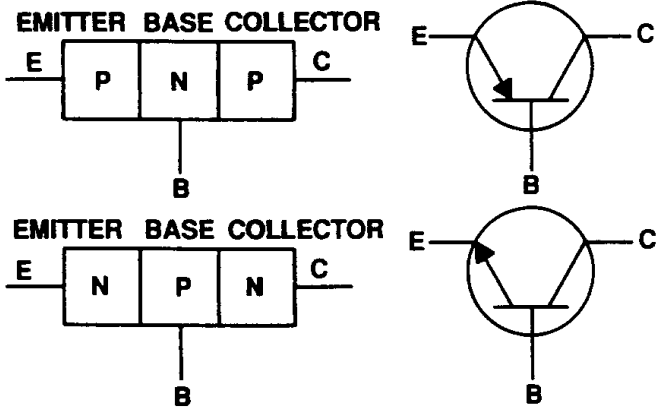
11-273.—11-283. [RESERVED.]