

REPORT No. 812

KNOCK-LIMITED PERFORMANCE OF SEVERAL INTERNAL COOLANTS

By DONALD R. BELLMAN and JOHN C. EYVARD

SUMMARY

The effect of internal cooling on the knock-limited performance of AN-F-28 fuel was investigated in a CFR engine, and the following internal coolants were used: (1) water, (2) methyl alcohol-water mixture, (3) ammonia-methyl alcohol-water mixture, (4) monomethylamine-water mixture, (5) dimethylamine-water mixture, and (6) trimethylamine-water mixture. The internal coolants were injected in the ratio of $\frac{1}{2}$ pound per pound of AN-F-28 fuel. Tests were run at inlet-air temperatures of 150° and 250° F to indicate the temperature sensitivity of the internal-coolant solutions.

In this investigation the use of methyl alcohol-water, monomethylamine-water, and dimethylamine-water mixtures as internal coolants raised the knock limit more than did water alone. The addition of ammonia to the methyl alcohol-water mixture lowered its knock-inhibiting effects. For most fuel-air ratios, the trimethylamine-water mixture decreased the knock-limited power.

INTRODUCTION

This report presents the results of tests carried out to determine the effect of several water-soluble internal coolants upon the knock-limited performance of AN-F-28 fuel. These tests are part of a general investigation of internal cooling of internal-combustion engines and were conducted at the NACA Cleveland laboratory in May and June 1943.

ENGINE AND AUXILIARY EQUIPMENT

Apparatus.—The tests were performed on a high-speed supercharged CFR engine coupled to a 100-horsepower, direct-current, cradle-type dynamometer and equipped with an aluminum piston, sodium-cooled exhaust and intake valves, and a cylinder with four spark-plug holes in the head. Knock was detected on a cathode-ray oscilloscope in conjunction with a magnetostriction pickup unit. All temperatures were measured by iron-constantan thermocouples and a self-balancing potentiometer. The arrangement of the spark plugs and knock indicator is shown in figure 1.

Determination of air flow.—The air flow for inlet-air pressures below 120 inches of mercury absolute was measured by a standard orifice and manometer or pressure-gage system. The air flow for inlet-air pressures higher than 120 inches of mercury absolute was calculated by straight-line extrapolation of the plot of inlet-air pressure against air flow. The

test was arbitrarily stopped when the inlet-air pressure reached 150 inches of mercury absolute. Figure 2 shows the schematic diagram of the inlet-air system.

Injection of fuel and internal coolant.—The fuel was injected by a high-pressure injection pump into a modified AFD 3-C inlet manifold parallel to the flow of air. Figure 3 is a schematic diagram of the fuel system.

The internal coolant was continuously injected at room temperature into the injection elbow just above the fuel injection nozzle and parallel to the air flow. A standard AFD 3-C inlet manifold was modified to permit this separate entry. The schematic diagram of the internal-coolant system is shown in figure 4.

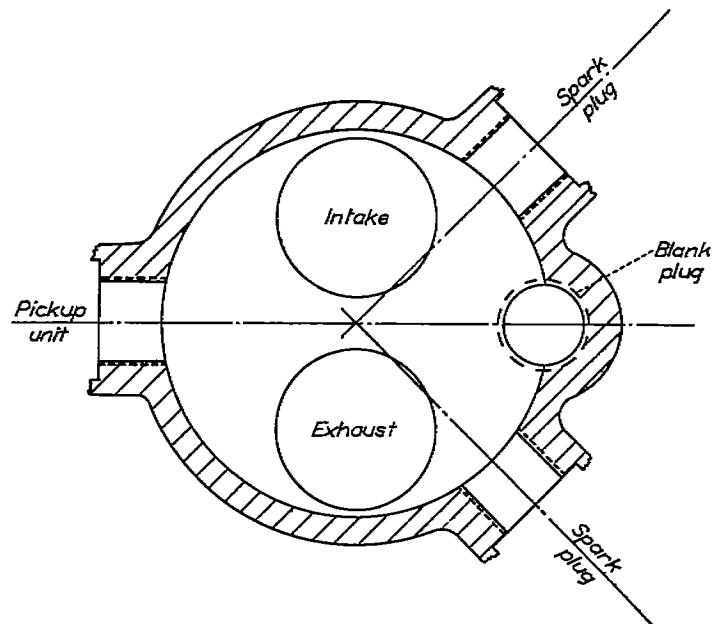

FIGURE 1.—Location of spark plugs and knock pickup unit in CFR cylinder.

PROCEDURE

All the data presented in this report are knock-limited. The range of operation was limited (1) by an artificial limit of 150 inches of mercury absolute in the inlet-air pressure, (2) by a maximum fuel flow of 30 pounds per hour, or (3) by preignition. In some cases spark-plug failure with concomitant preignition caused temporary shutdowns. If surface ignition occurred (usually observed as continuous afterfiring), the knock-limited data were recorded and the data points

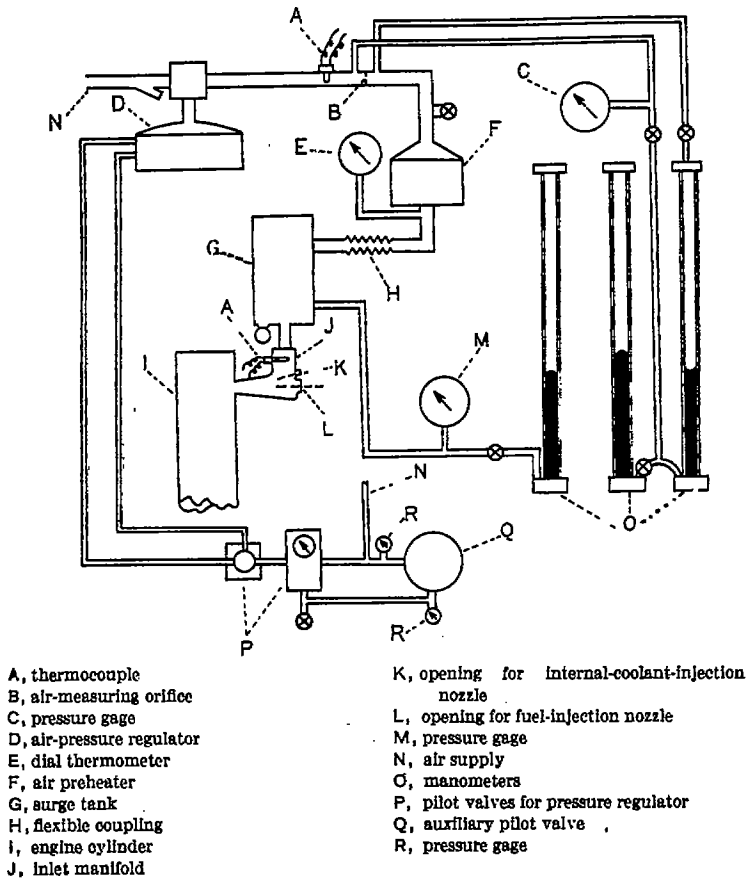

FIGURE 2.—Diagram of inlet-air system.

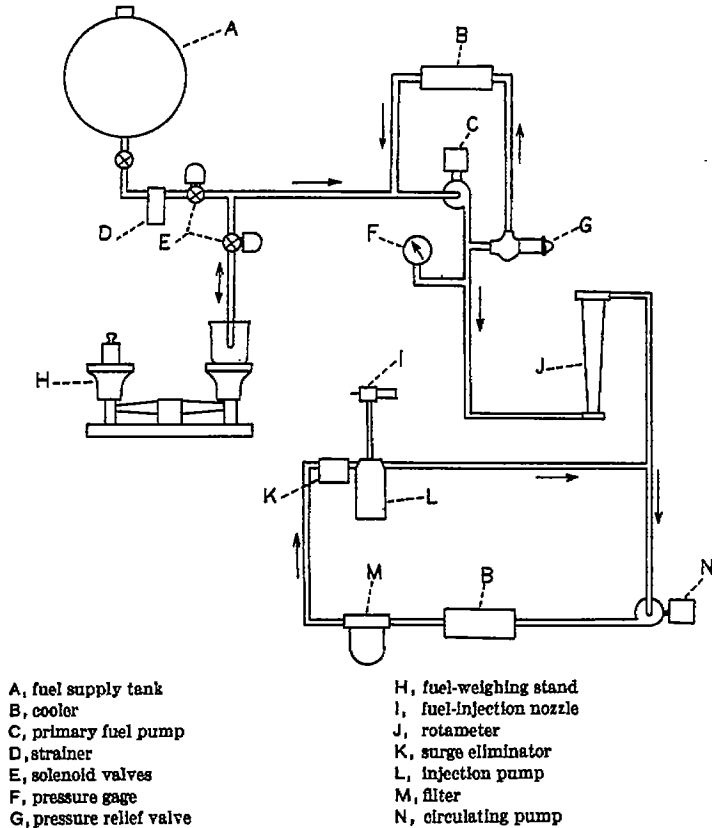

FIGURE 3.—Diagram of fuel system.

were labeled "surface ignition." They are shown as solid points on the curves of variation of indicated mean effective pressure and inlet-air pressure with fuel-air ratio. The following engine conditions were maintained constant:

Engine speed, rpm.....	2500
Compression ratio.....	7.0
Inlet-coolant temperature, ° F.....	250
Inlet-air temperature, ° F.....	150, 250
Spark advance, deg B. T. C.....	30
Oil temperature, ° F.....	150

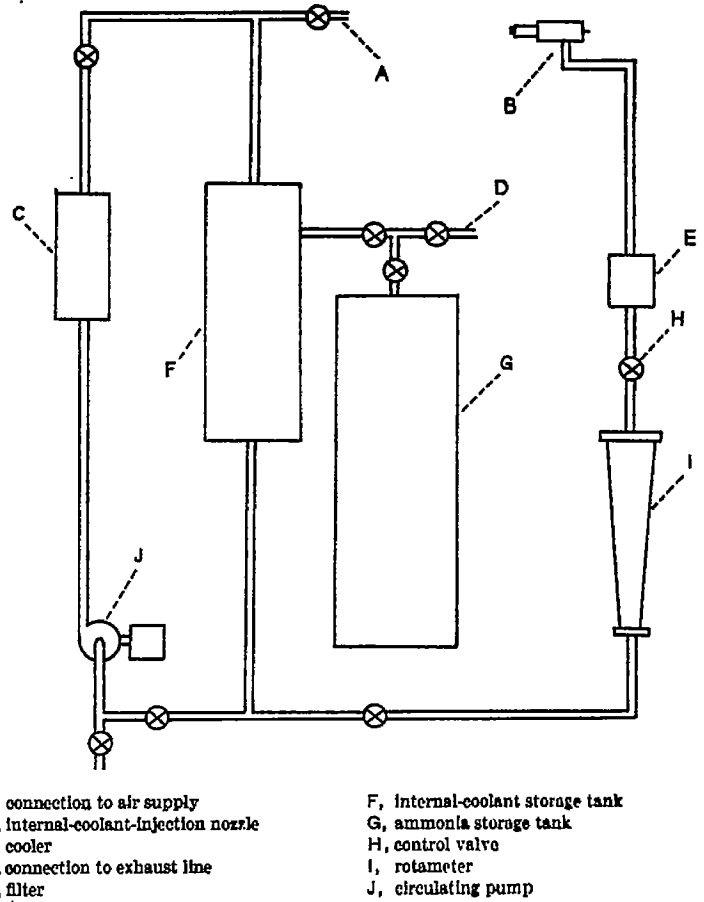

FIGURE 4.—Diagram of internal-coolant injection system.

The internal coolants were added in the ratio of 1/2 pound per pound of fuel as measured by a special rotameter. A single lot of AN-F-28 fuel was used for the entire investigation. The following internal coolants were investigated:

1. Water
2. A mixture of 70-percent technical methyl alcohol plus 30-percent water by volume
3. A mixture of 70-percent technical methyl alcohol plus 30-percent water by volume, concentrated with anhydrous ammonia to 30-percent ammonia by weight of the final solution
4. A mixture of 32-percent commercial monomethylamine plus 68-percent water by weight

5. A mixture of 26-percent commercial dimethylamine plus 74-percent water by weight

6. A mixture of 29-percent commercial trimethylamine plus 71-percent water by weight

Some of the properties of the amine solutions are listed in table I.

TABLE I

SUMMARY OF CHEMICAL AND PHYSICAL PROPERTIES OF AMINE-WATER SOLUTIONS

Solution	Weight percentage of amine (by alkalinity)	Density	Peroxides	Aldehydes	Freezing point (° F)
4 Monomethylamine-water mixture.	32	0.925	Negative...	Negative...	-40
5 Dimethylamine-water mixture.	26	.939	...do...	Trace...	-0.4
6 Trimethylamine-water mixture.	29	.937	...do...	...do...	27 to 30

During the course of each test, the variation of rotameter reading (fuel flow) with inlet-air pressure (air flow) was drawn. This plot gave an immediate indication of the correctness of each knock-limited point. Before each internal coolant was tested, two points in the rich region for the fuel alone were checked on the plot of inlet-air pressure as a function of rotameter reading. This check indicated whether the engine was operating satisfactorily. For each set of data, the check plots of fuel flow (fuel-weighing stand) against fuel rotameter reading and air flow against inlet-air pressure were drawn. This procedure insured that both the fuel measurement and the air-flow measurement were consistent.

The flow of the internal coolant was measured by a special aluminum-bob rotameter, the setting of which was determined from the reading of the fuel rotameter. Both fuel and internal-coolant rotameters were calibrated over the entire range by timing the flow of a specified weight of each fuel or internal coolant. When the internal-coolant solution containing ammonia was calibrated, the fluid from the rotameter was emptied into an acid medium. This procedure neutralized the ammonia and minimized the weight loss due to volatility.

In the rich region the fuel flow and the internal-coolant flow were first fixed before obtaining the knock point. The air flow was increased until incipient knock occurred. In the lean region the inlet-air pressure was first fixed; the fuel and the internal coolant were then simultaneously increased until incipient knock occurred. Most of the points were checked for possible afterfiring.

RESULTS AND DISCUSSION

Figures 5 (a) and 5 (b) compare, at an inlet-air temperature of 250° F, the knock-limited performance of AN-F-28 fuel and AN-F-28 fuel plus each of the following internal coolants: water, 70-30 percent by volume technical methyl alcohol-water solution, and the 70-30 percent by volume technical methyl alcohol-water solution containing 30 percent ammonia by weight.

If the relative power ratio is defined as the ratio of knock-

limited indicated mean effective pressure obtained with the fuel plus the internal coolant to knock-limited indicated mean effective pressure obtained with the fuel alone, at a fuel-air ratio of 0.06 the relative power ratios for the three internal coolants are 1.52, 1.59, and 1.47, respectively. At a fuel-air ratio of 0.085, these relative power ratios are 1.34, 1.80, and 1.65.

The use of water improved the lean-mixture response considerably more than the rich. The addition of ammonia to the methyl alcohol-water solution lowered the knock-limited performance over the entire range of fuel-air ratios. Water raised the indicated specific fuel consumption, but the other coolants lowered the fuel consumption at low fuel-air ratios. The addition of ammonia to the alcohol-water mixture promoted surface ignition in the rich region.

The knock-limited performance of the internal coolants at an inlet-air temperature of 150° F is compared in figures 5 (c) and 5 (d). At a fuel-air ratio of 0.06, the relative power ratios of water, alcohol-water, and ammonia-alcohol-water mixtures are 1.27, 1.68, and 1.29, respectively; whereas, at a fuel-air ratio of 0.085, these values are 1.12, 1.59, and 1.49. A comparison of figures 5 (a) and 5 (c) shows that a methyl alcohol-water solution is highly temperature-sensitive. Strangely enough, addition of ammonia to this solution decreased its temperature sensitivity, and the curve shape was more nearly the same at both temperatures. The alcohol-water solution showed an extremely high lean-mixture response at an inlet-air temperature of 150° F. At a fuel-air ratio of 0.043, the engine developed a knock-limited indicated mean effective pressure of 558 pounds per square inch, accompanied by indicated specific fuel and liquid consumptions of 0.37 and 0.55 pound per indicated horsepower-hour, respectively. These consumptions did not increase rapidly in this very lean region. The engine showed no tendency toward rough running.

The second group of internal coolants compared include: 70-30 percent by volume technical methyl alcohol-water solution, a commercial 32-68 percent by weight monomethylamine-water solution, a commercial 26-74 percent by weight dimethylamine-water solution, and a commercial 29-71 percent by weight trimethylamine-water solution. Data showing the knock-limited performance at an inlet-air temperature of 250° F of AN-F-28 fuel and AN-F-28 fuel plus each of these internal coolants are plotted in figures 6 (a) and 6 (b). At a fuel-air ratio of 0.06, the relative power ratios of these coolants are 1.59, 1.81, 1.78, and 0.85, respectively. At a fuel-air ratio of 0.085, the relative power ratios are 1.80, 1.84, 2.04, and 0.83.

Both monomethylamine and dimethylamine showed marked improvement over alcohol as knock suppressors. The monomethylamine showed better lean-mixture characteristics than the dimethylamine, but the reverse was true in the rich region. This reversal of order may have been due to the fact that, in the rich region of the monomethylamine curve, continuous afterfiring was encountered; that is, the ignition could be turned on or off with little change in the power output. Slight decreases of the power level below the knock point eliminated this surface ignition.

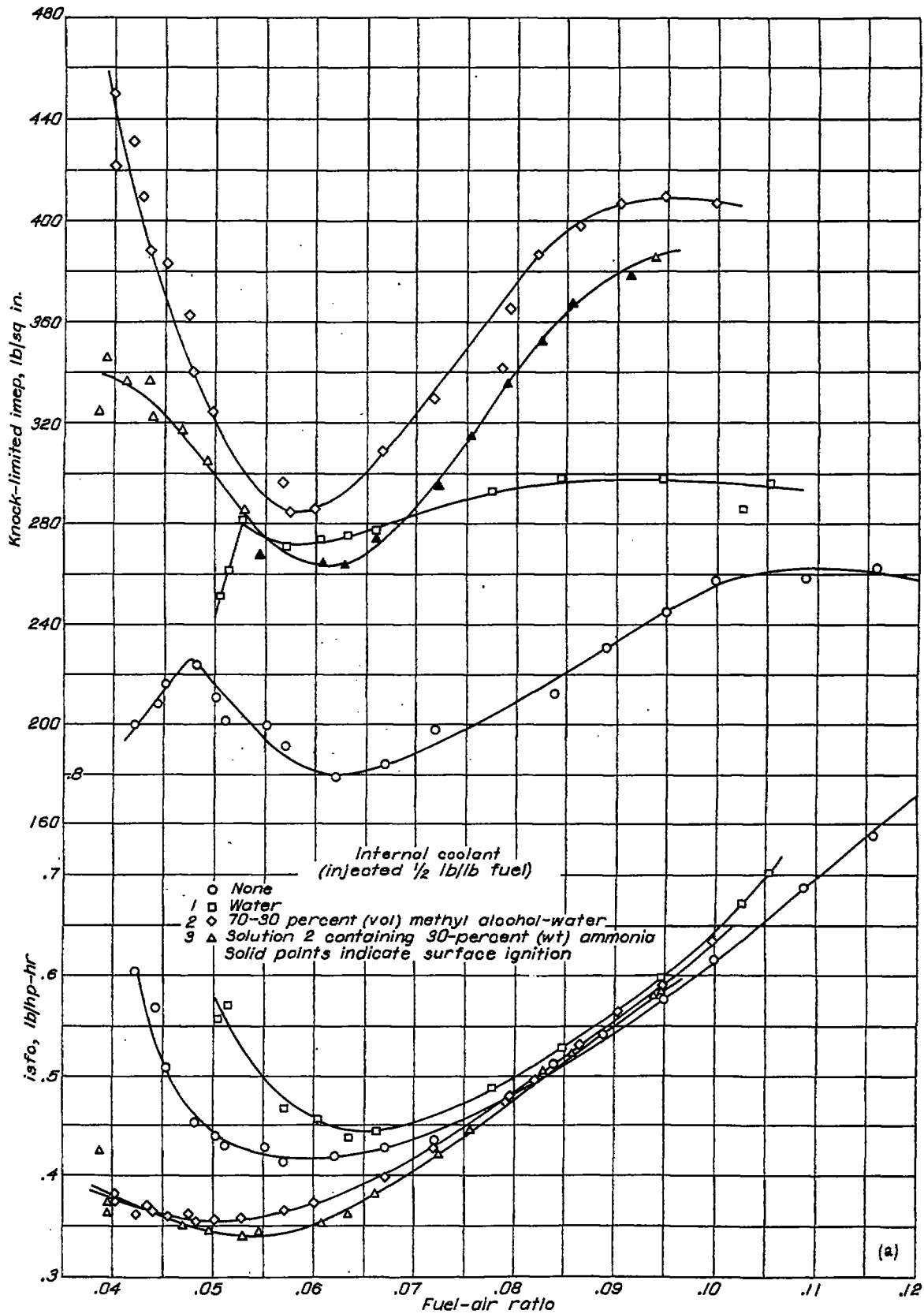

(a) Variation of indicated specific fuel consumption and knock-limited indicated mean effective pressure with fuel-air ratio at inlet-air temperature of 250° F.

FIGURE 5.—Effect of internal coolants 1, 2, and 3 on knock-limited engine performance. CFR engine; fuel, AN-F-28; compression ratio, 7.0; inlet-coolant temperature, 250° F; spark advance, 30° B. T. C.; engine speed, 2500 rpm.

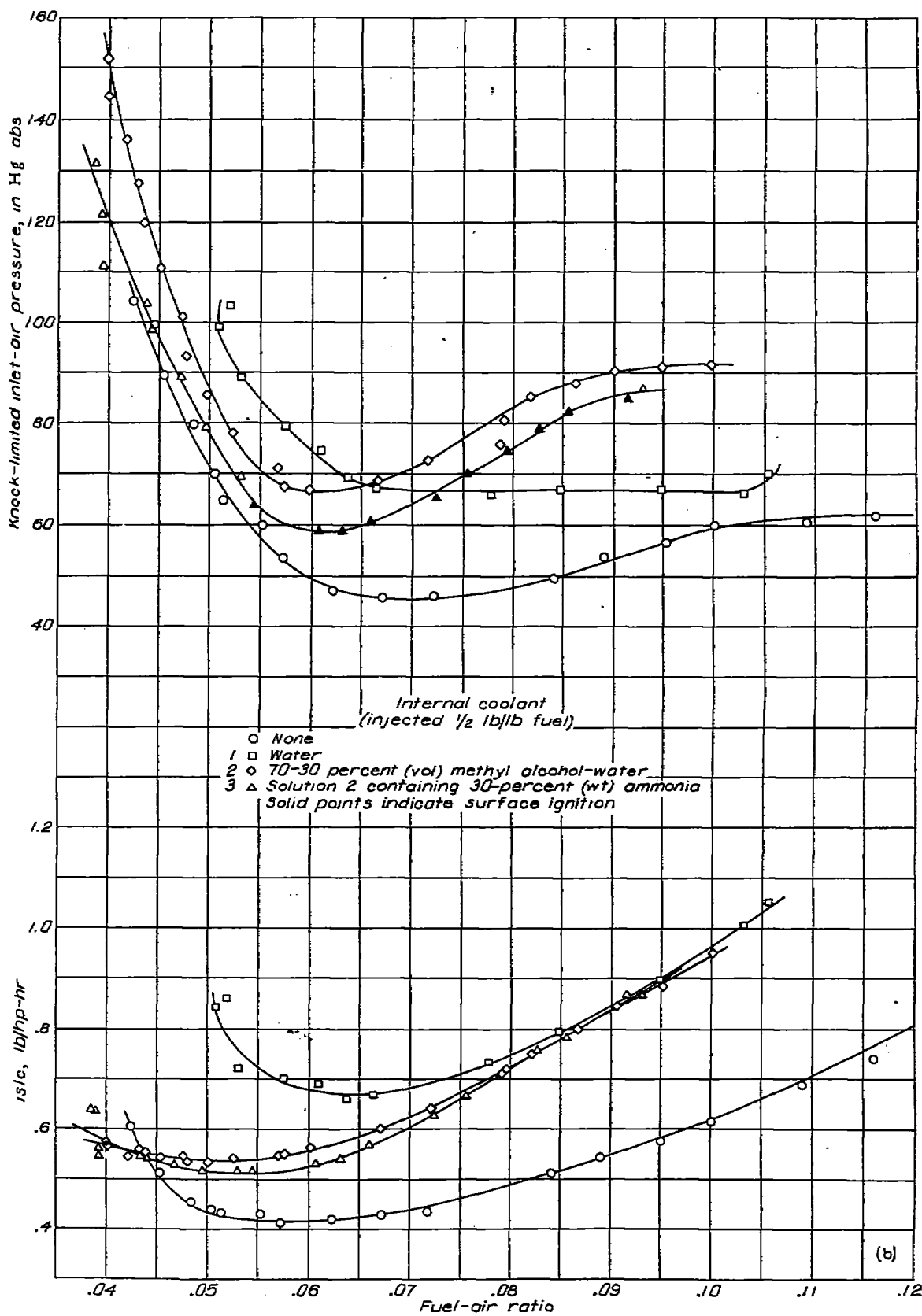

(b) Variation of indicated specific liquid consumption and knock-limited inlet-air pressure with fuel-air ratio at inlet-air temperature of 250° F.

FIGURE 5.—Continued.

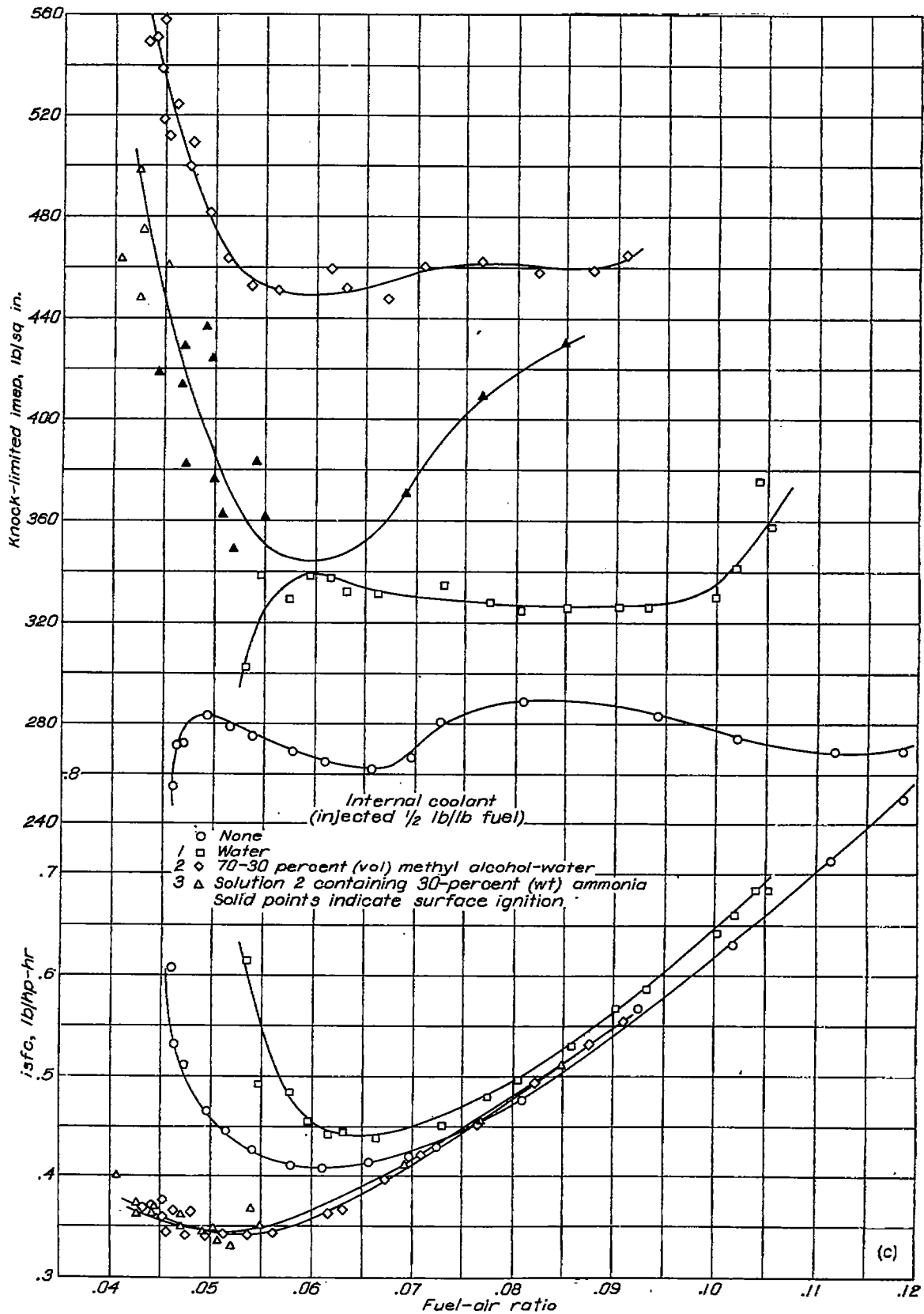

(c) Variation of indicated specific fuel consumption and knock-limited indicated mean effective pressure with fuel-air ratio at inlet-air temperature of 150° F.

FIGURE 5.—Continued.

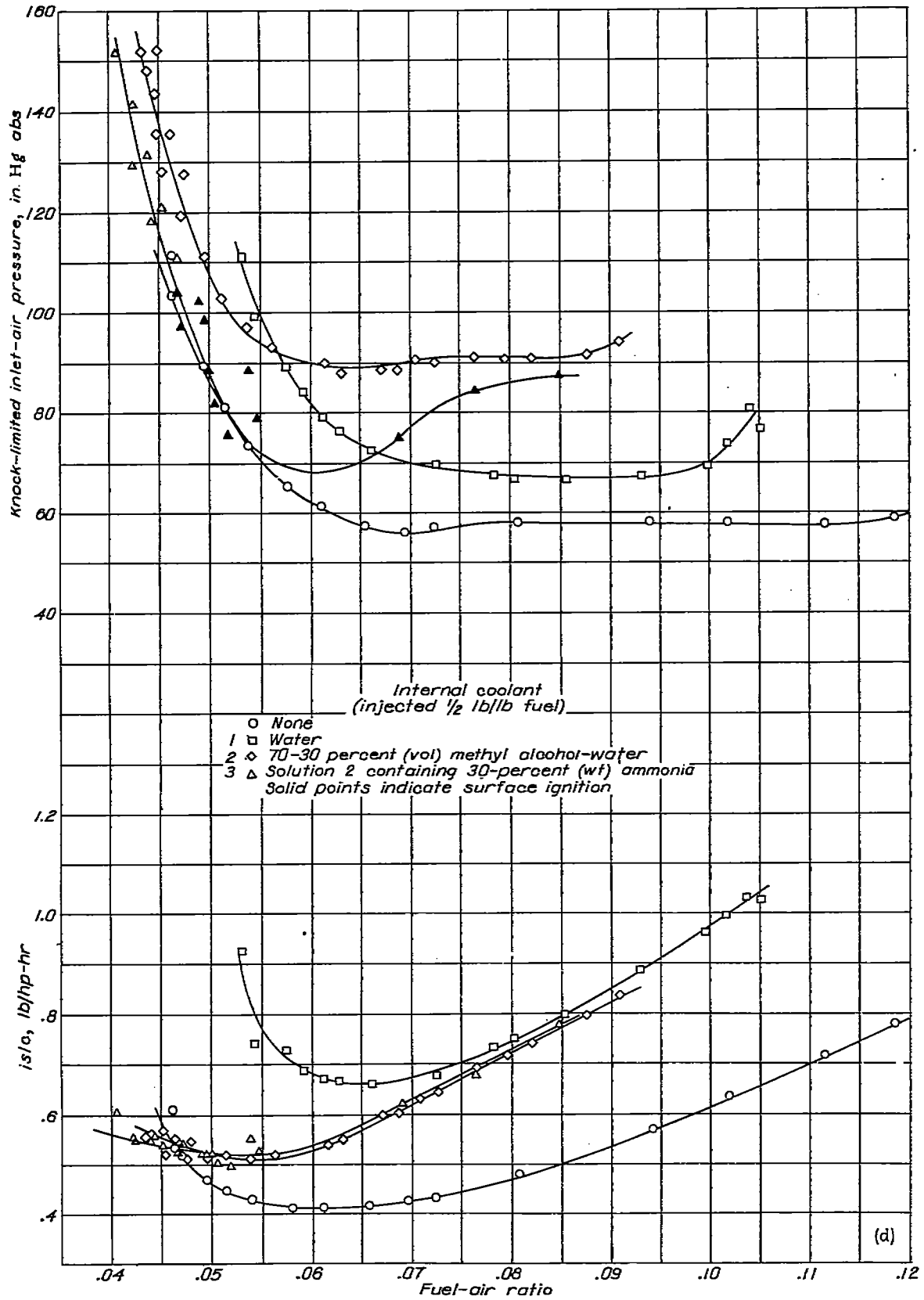

(d) Variation of indicated specific liquid consumption and knock-limited inlet-air pressure with fuel-air ratio at inlet-air temperature of 150° F.

FIGURE 5.—Concluded.

On the lean side of the curve, the monomethylamine-water test was arbitrarily stopped when the boost pressure reached 150 inches of mercury absolute. As with the methyl alcohol-water mixture, no tendency toward uneven firing was experienced. At a fuel-air ratio of 0.044, an indicated mean effective pressure of 495 pounds per square inch was reached. The corresponding indicated specific fuel and liquid consumptions were 0.38 and 0.56 pound per indicated horsepower-hour, respectively.

The trimethylamine-water mixture lowered the knock-limited performance of the fuel. All the amines lowered the indicated specific fuel consumption, in some cases to an amount greater than can be explained by considering the contributions of the internal coolant to the heat of combustion.

The knock-limited performance data of the internal coolants at an inlet-air temperature of 150° F are compared in figures 6 (c) and 6 (d). At a fuel-air ratio of 0.049, the monomethylamine allowed a knock-limited indicated mean effective pressure of 620 pounds per square inch with indicated specific fuel and liquid consumptions of 0.37 and 0.55 pound per indicated horsepower-hour, respectively. This output amounted to 1.96 indicated horsepower per cubic inch of engine displacement. The occurrence of preignition prevented the measurement of rich-mixture response. The temperature sensitivities as measured by the ratio of the indicated mean effective pressures at inlet-air temperatures of 150° and 250° F of monomethylamine, dimethylamine, and trimethylamine were about the same. A limited supply of dimethylamine-water solution prevented completion of the rich-region response measurement.

The relative increase in the knock-limited power obtained with the various internal-coolant mixtures for four different fuel-air ratios is shown in table II. The temperature sensitivity of the internal-coolant mixtures is presented in table III in which a comparison is made of the knock-limited power obtained at inlet-air temperatures of 150° and 250° F.

TABLE II
IMPROVEMENT IN KNOCK-LIMITED ENGINE
PERFORMANCE OF AN-F-28
FUEL ACHIEVED BY INTERNAL COOLING

[CFR engine; compression ratio, 7.0; inlet-air temperature, 250° F; inlet-coolant temperature, 250° F; spark advance, 30° B. T. C.; engine speed, 2500 rpm]

Internal coolant (injected 1/4 lb/lb fuel)		Relative power ratio $\frac{\text{imep (fuel + internal coolant)}}{\text{imep (fuel alone)}}$			
		Fuel-air ratio			
		0.05	0.06	0.08	0.09
1	None	1.00	1.00	1.00	1.00
2	Water	1.14	1.52	1.41	1.28
3	Methyl alcohol-water mixture (70-30 percent by volume)	1.51	1.59	1.80	1.75
4	Monomethylamine-water mixture (32-68 percent by weight)	1.08	* 1.81	* 1.86	* 1.83
5	Dimethylamine-water mixture (26-74 percent by weight)	1.82	1.78	1.98	

* Afterfiring encountered

A plot of the knock-limited indicated mean effective pressure as a function of the inlet-air pressure at an inlet-air temperature of 250° F is presented in figure 7 for AN-F-28 fuel with and without each of the following internal coolants: water, 70-30 percent by volume methyl alcohol-water solution, a commercial 32-68 percent by weight monomethylamine-water solution, and a commercial 26-74 percent by weight dimethylamine-water solution.

For a fixed inlet-air pressure, the indicated mean effective pressure was roughly proportional to the fuel flow in the lean region; therefore, at constant inlet-air pressure the internal coolant that allowed the highest knock-limited fuel flow allowed the greatest indicated mean effective pressure. At an inlet-air pressure of 150 inches of mercury absolute, the indicated mean effective pressures of alcohol and monomethylamine were 448 and 492 pounds per square inch, respectively. This effect would be an important consideration if knock-limited lean-mixture performance were contemplated.

The trend of the indicated-mean-effective-pressure curves in the rich region shows that the indicated mean effective pressure was very nearly a straight-line function of the air flow even though the fuel-air ratio and the internal coolants were varied. For a given knock-limited indicated mean effective pressure, lean-mixture operation requires more air flow than rich-mixture operation. At a knock-limited indicated mean effective pressure of 400 pounds per square inch, achieved by monomethylamine-water solution, the rich and lean inlet-air pressures were 88 and 103 inches of mercury absolute, respectively. The choice between rich-mixture and lean-mixture operation would depend upon the balance between supercharger capacity and allowable fuel consumption as well as upon the uniformity of the mixture distribution in the lean region.

TABLE III
EFFECT OF INLET-AIR TEMPERATURE
ON KNOCK-LIMITED ENGINE
PERFORMANCE OF AN-F-28 FUEL USED IN
CONJUNCTION WITH INTERNAL COOLANTS

[CFR engine; compression ratio, 7.0; inlet-coolant temperature, 250° F; spark advance, 30° B. T. C.; engine speed, 2500 rpm]

Internal coolant (injected 1/4 lb/lb fuel)		$\frac{\text{imep, 150° F inlet-air temperature}}{\text{imep, 250° F inlet-air temperature}}$			
		Fuel-air ratio			
		0.05	0.06	0.08	0.09
1	None	1.24	1.46	1.32	1.20
2	Water		1.23	1.11	1.09
3	Methyl alcohol-water mixture (70-30 percent by volume)	1.46	1.57	1.23	1.13
4	Monomethylamine-water mixture (32-68 percent by weight)	1.43			
5	Dimethylamine-water mixture (26-74 percent by weight)	1.42	* 1.51		

* Afterfiring encountered at an inlet-air temperature of 150° F

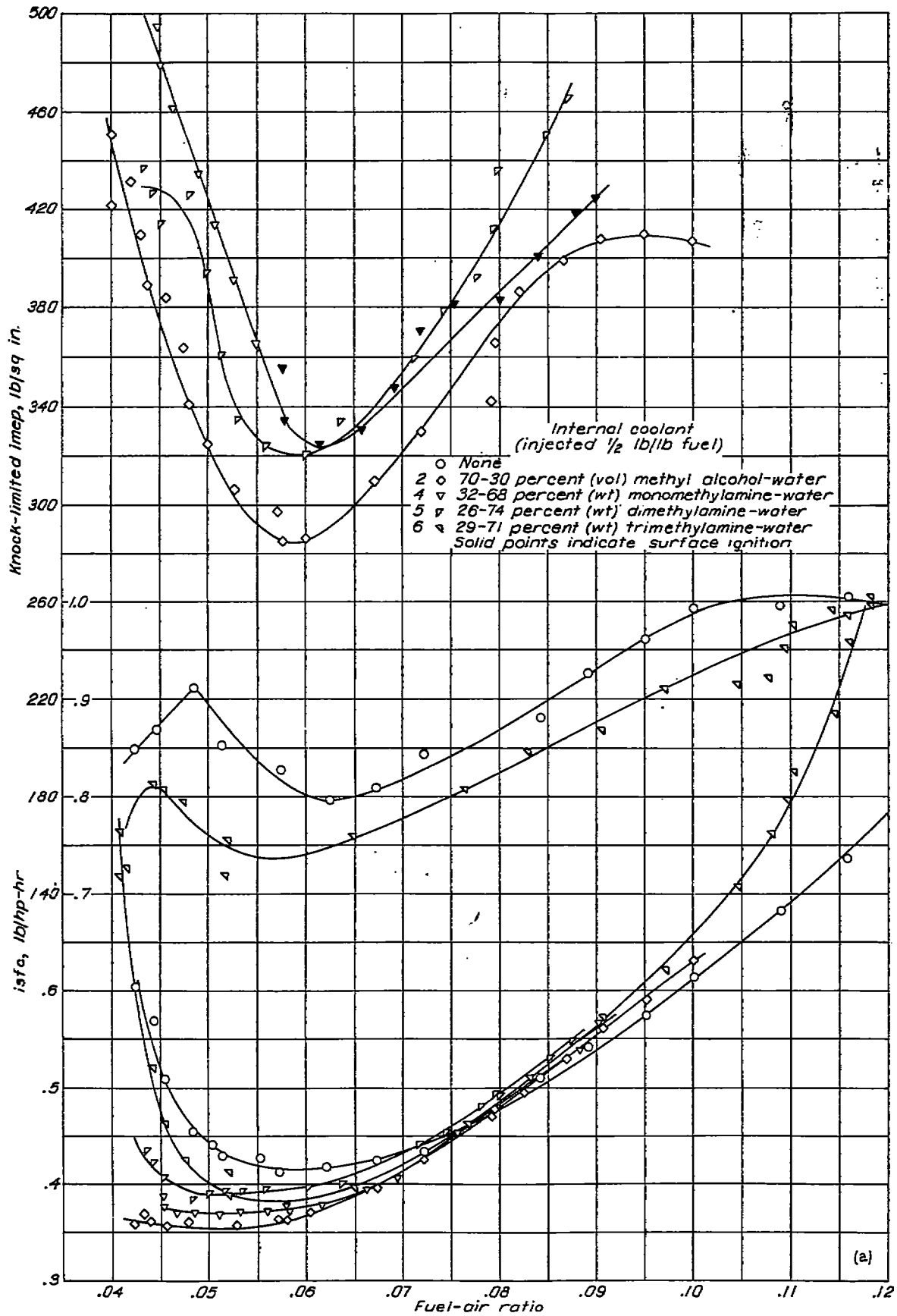

(a) Variation of indicated specific fuel consumption and knock-limited indicated mean effective pressure with fuel-air ratio at inlet-air temperature of 250° F.

FIGURE 6.—Effect of internal coolants 2, 4, 5, and 6 on knock-limited engine performance. CFR engine; fuel, AN-F-28; compression ratio, 7.0; Inlet-coolant temperature, 250° F; spark advance, 30° B. T. C.; engine speed, 2500 rpm.

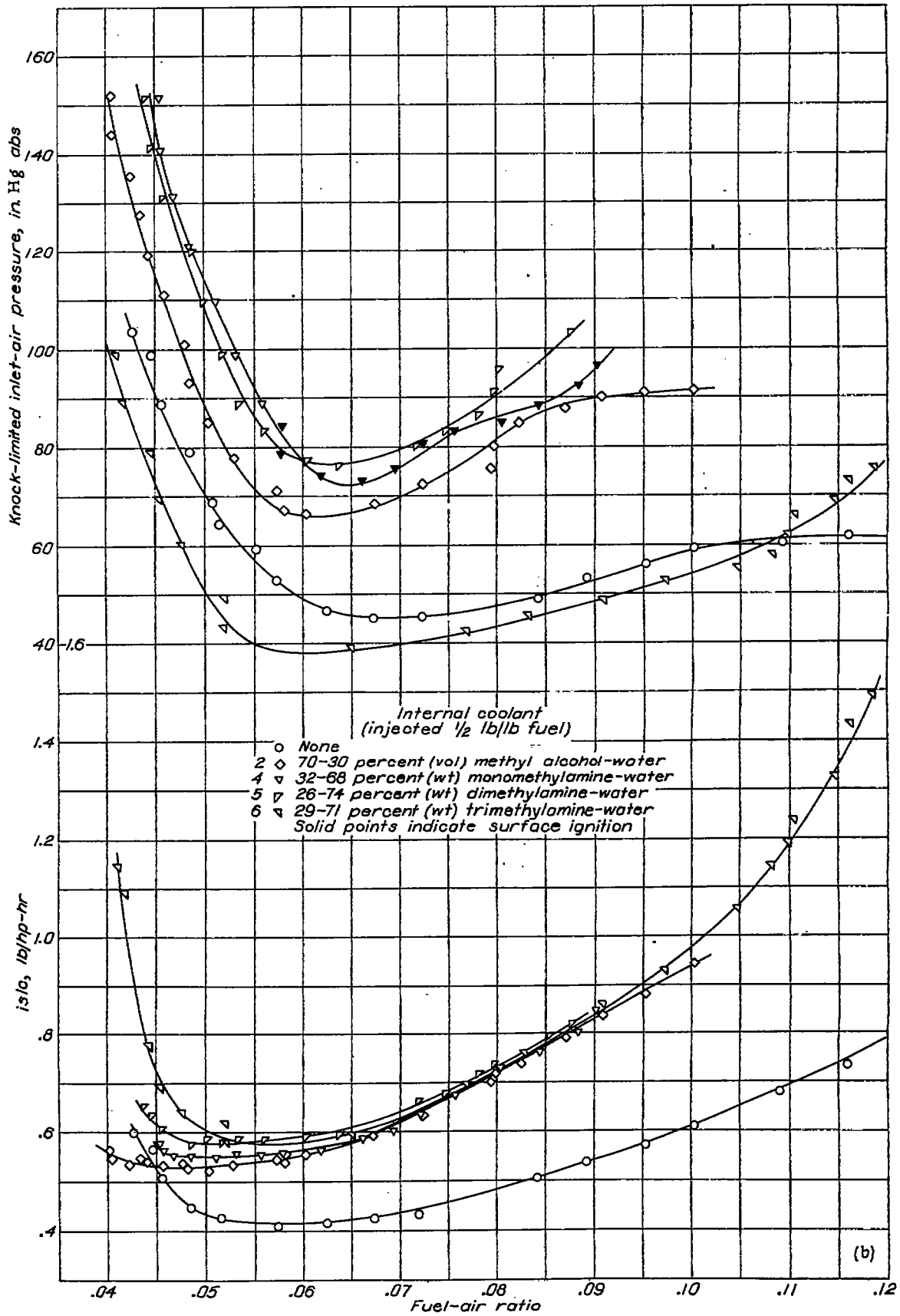

(b) Variation of indicated specific liquid consumption and knock-limited inlet-air pressure with fuel-air ratio at inlet-air temperature of 250° F.

FIGURE 6.—Continued.

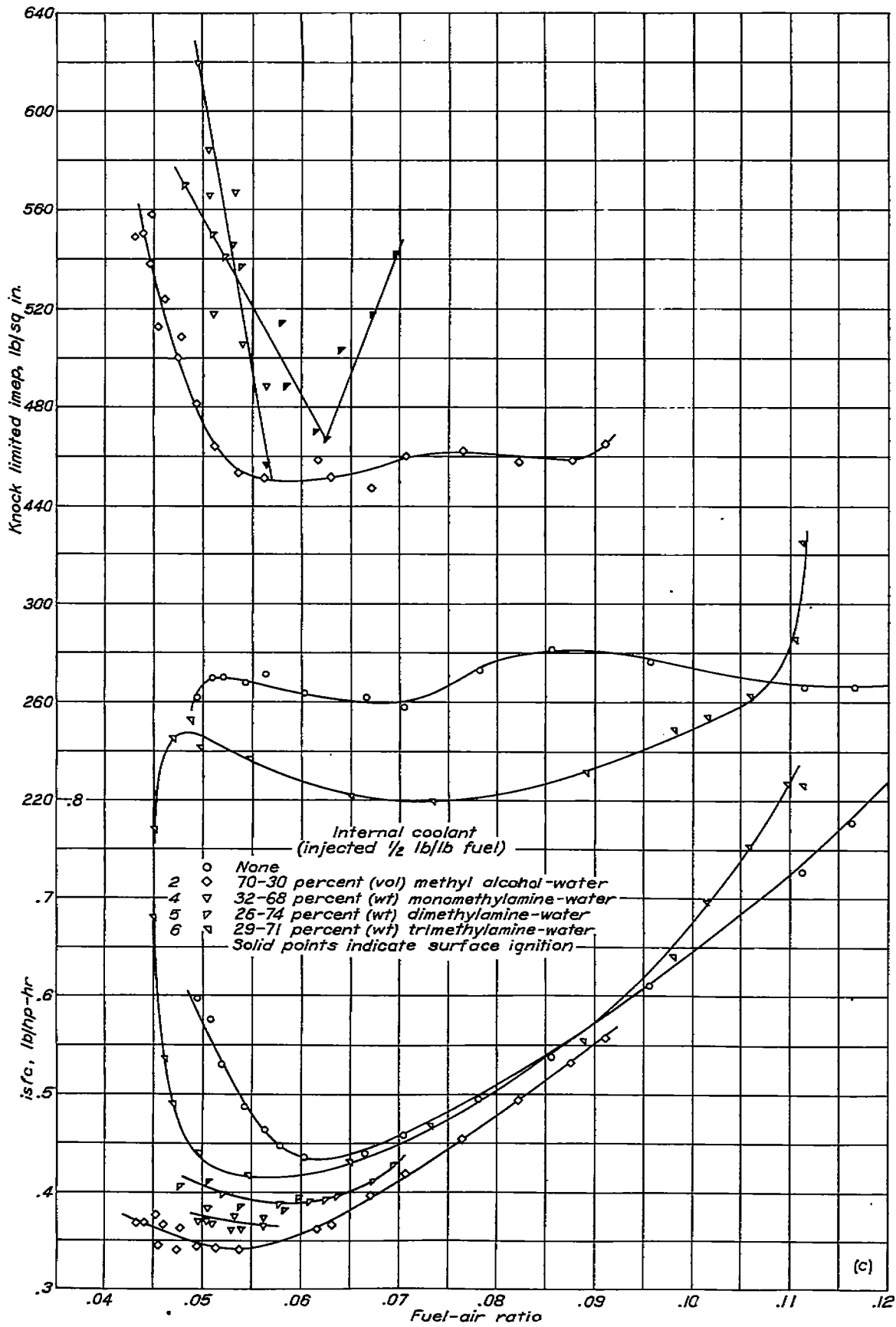

(c) Variation of indicated specific fuel consumption and knock-limited indicated mean effective pressure with fuel-air ratio at inlet-air temperature of 150° F.

FIGURE 6.—Continued.

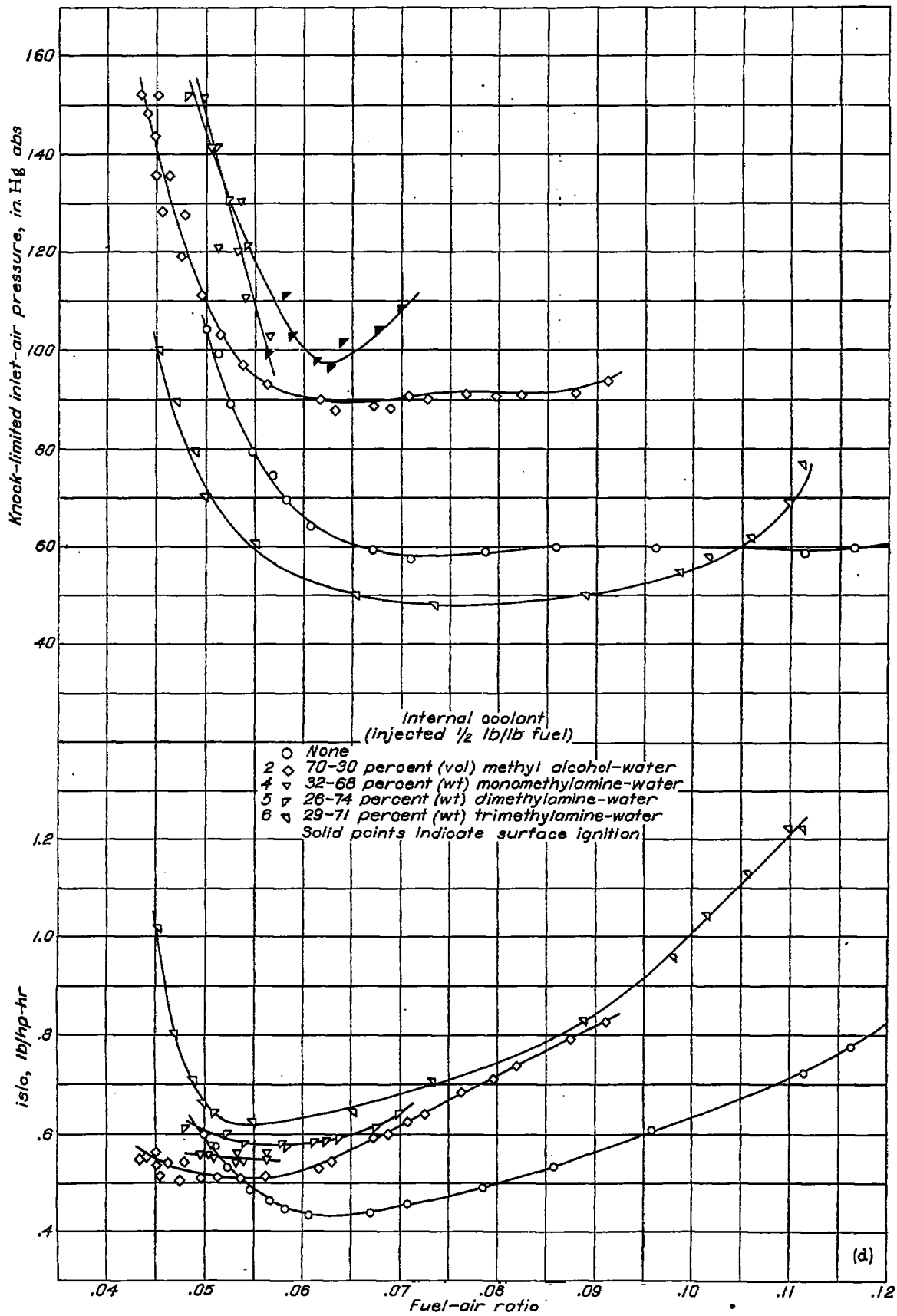

(d) Variation of indicated specific liquid consumption and knock-limited inlet-air pressure with fuel-air ratio at inlet-air temperature of 150° F.

FIGURE 6.—Concluded.

Knock-limited indicated mean effective pressure as a function of indicated specific liquid consumption for the internal coolants of figure 7 is plotted in figure 8. Water raised the indicated mean effective pressure at considerable expense to the indicated specific liquid consumption. For knock-limited indicated mean effective pressures above about 240 pounds per square inch, methyl alcohol - water and monomethylamine-water solutions were more economical from weight considerations than fuel alone.

SUMMARY OF RESULTS

From the results of an investigation of the effect of internal cooling on the knock-limited performance of AN-F-28 fuel, the following results were obtained:

1. In all cases the use of methyl alcohol - water, monomethylamine-water, and dimethylamine-water mixtures as internal coolants raised the knock-limited performance of AN-F-28 fuel more than did water alone.
2. The addition of ammonia to the methyl alcohol - water solution as an internal coolant lowered the knock-inhibiting effects of the solution and also promoted surface ignition.
3. The commercial trimethylamine-water solution lowered the knock-limited performance of the AN-F-28 fuel except in the very rich mixture region.

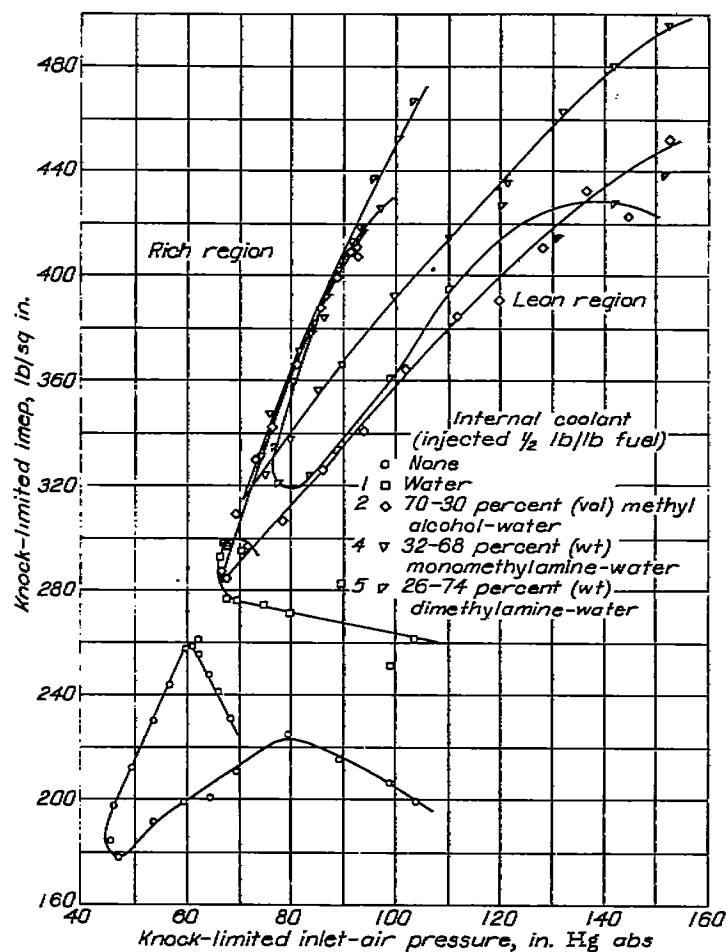

FIGURE 7.—Effect of internal coolants 1, 2, 4, and 5 on relation between knock-limited inlet-air pressure and knock-limited indicated mean effective pressure. CFR engine; fuel, AN-F-28; compression ratio, 7.0; inlet-coolant temperature, 250° F; inlet-air temperature, 250° F; spark advance, 30° B. T. C.; engine speed, 2500 rpm.

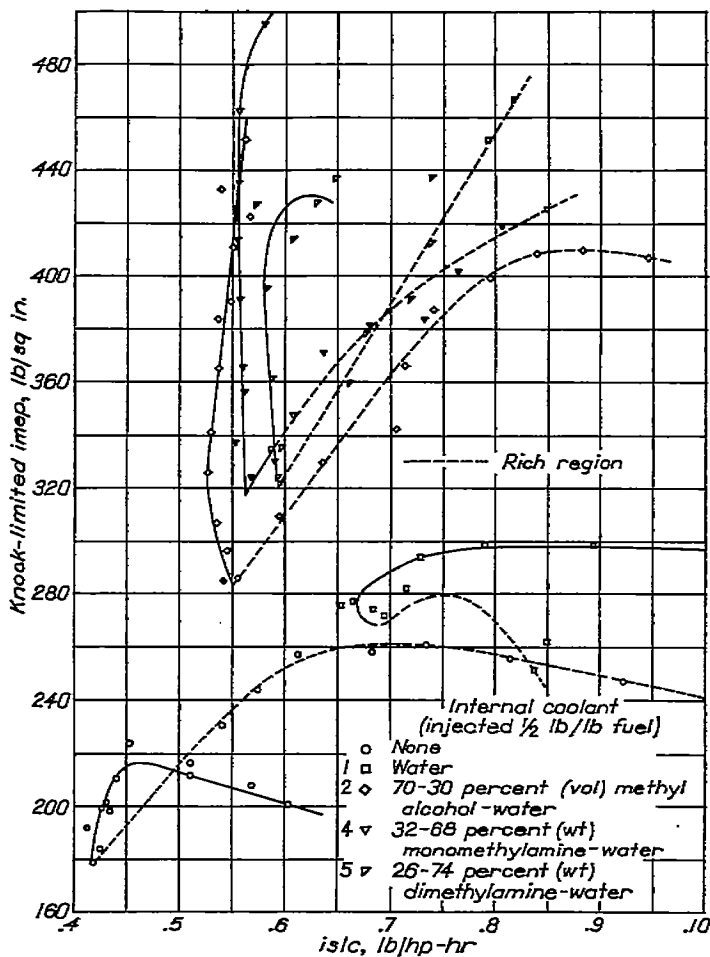

FIGURE 8.—Effect of internal coolants 1, 2, 4, and 5 on relation between indicated specific liquid consumption and knock-limited mean effective pressure. CFR engine; fuel, AN-F-28; compression ratio, 7.0; inlet-coolant temperature, 250° F; inlet-air temperature, 250° F; spark advance, 30° B. T. C.; engine speed, 2500 rpm.

4. At fuel-air ratios of 0.05 or less, extremely high knock-limited powers could be obtained by using internal coolants.
5. At fuel-air ratios lower than the stoichiometric-mixture ratio, addition of each of the internal coolants except water lowered the indicated specific fuel consumption, in some cases to an amount greater than can be explained by considering the contributions of the internal coolant to the heat of combustion.
6. Internal cooling at extremely low fuel-air ratios allowed high knock-limited powers at much lower indicated specific liquid consumptions than were obtained when operating at high fuel-air ratios either with or without internal cooling. (Lean-mixture operation, of course, implies high indicated specific air consumptions.)
7. The use of monomethylamine-water mixture at an inlet-air temperature of 150° F and a fuel-air ratio of 0.049 allowed a knock-limited power of 1.96 horsepower per cubic inch of cylinder displacement (imep of 620 lb/sq in.). The corresponding indicated specific fuel and liquid consumptions were 0.37 and 0.55 pound per horsepower-hour, respectively.

AIRCRAFT ENGINE RESEARCH LABORATORY,
 NATIONAL ADVISORY COMMITTEE FOR AERONAUTICS,
 CLEVELAND, OHIO, February 1, 1944.