

REPORT No. 657

THE INFLUENCE OF DIRECTED AIR FLOW ON COMBUSTION IN A SPARK-IGNITION ENGINE

By A. M. ROTHROCK and R. C. SPENCER

SUMMARY

The air movement within the cylinder of the N. A. C. A. combustion apparatus was regulated by using shrouded inlet valves and by fairing the inlet passage. Rates of combustion were determined at different inlet-air velocities with the engine speed maintained constant and at different engine speeds with the inlet-air velocity maintained approximately constant.

The rate of combustion increased when the engine speed was doubled without changing the inlet-air velocity; the observed increase was about the same as the increase in the rate of combustion obtained by doubling the inlet-air velocity without changing the engine speed.

Certain types of directed air movement gave great improvement in the reproducibility of the explosions from cycle to cycle, provided that other variables were controlled.

Directing the inlet air past the injection valve during injection increased the rate of burning.

INTRODUCTION

The efficient utilization of fuel in an internal-combustion engine embodies two main operations: The introduction and the mixing of the fuel with the air charge, and the combustion of the charge after it is mixed. During the course of the general program of research on combustion at the laboratories of the N. A. C. A., detailed investigations have been carried out and a large amount of fundamental information has been obtained concerning mixture formation, distribution, and the combustion in the engine. It has long been recognized that air movement is of value in attaining higher engine efficiencies, and the program of research has included investigations of the effects of air flow on the fuel spray and on the combustion in a compression-ignition engine (references 1, 2, and 3).

Interest in the use of air flow in spark-ignition engines has greatly increased in recent years and, in recognition of the need for additional information concerning air flow and its effects on combustion, this program of research has been extended. Various types of air

movement (without combustion) have been investigated in detail using the N. A. C. A. glass-cylinder engine (reference 4). Concurrently the investigation reported herein was conducted during the summer of 1937 to determine the effects of directed air flow on combustion; the N. A. C. A. combustion apparatus was used.

APPARATUS AND METHOD

The N. A. C. A. combustion apparatus has been described in references 5 and 6. Briefly, it is a 5- by 7-inch single-cylinder test engine with a large glass window in the cylinder head to permit the combustion to be studied photographically. The engine is driven at the test speed by an electric motor and is then fired once by injecting and igniting a single charge of fuel. The cylinder-wall temperature is maintained by circulating heated glycerin through the jacket. A diagrammatic sketch of the apparatus is shown in figure 1. The cylinder head is of the pent-roof type normally having two exhaust and two inlet valves. In the present design, the space occupied by the two exhaust valves is used for the glass window. As the engine fires only once, the two inlet valves operate simultaneously and serve both for inlet and exhaust.

The directed air movement was obtained by shrouding the valves as shown in figure 2. The valve arrangements are shown in figure 3 and are designated by the letters used by Lee in reference 4. Conditions B and C (intermediate between A and D, in the setting of the rear valve) were omitted in the combustion tests. In one set of experiments, only one valve was used and the inlet passage was faired so as to direct the incoming air tangentially.

The ignition system has been described in reference 5. It is especially designed to provide accurate spark timing, and the maximum variation in timing is not greater than ± 1 crankshaft degree.

The N. A. C. A. spark-photography apparatus (reference 7) and the N. A. C. A. optical-type pressure indicator (reference 8) were used in conjunction with the combustion apparatus in this study

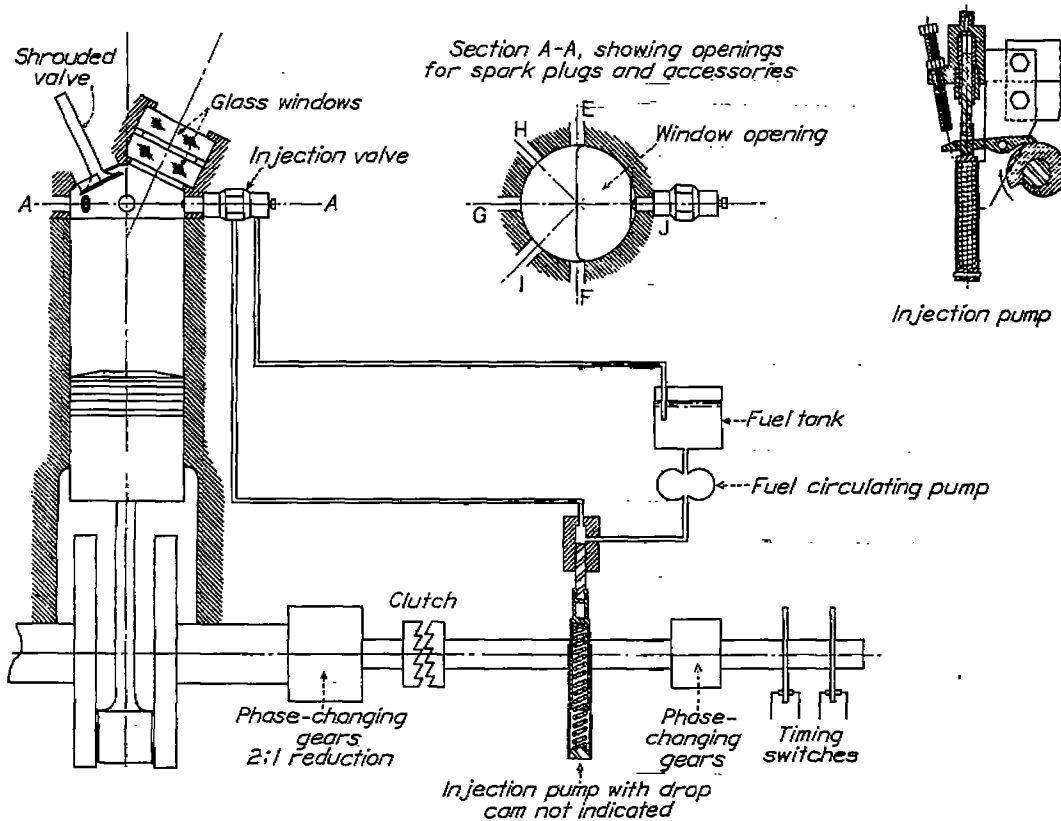

FIGURE 1.—Diagrammatic sketch of combustion apparatus.

The spark-photography apparatus consists of a battery of high-voltage condensers and a rotary distributor so arranged that the condensers are discharged consecutively, furnishing a series of spark discharges. For

detailed description of the set-up and the method of interpreting the pictures is given in reference 5.

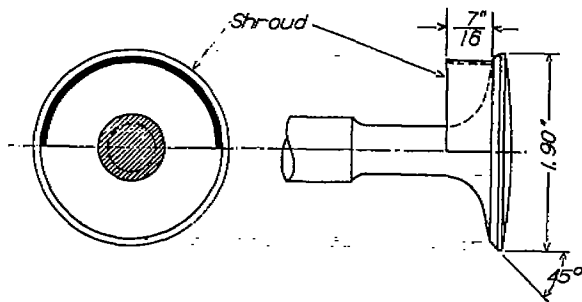

FIGURE 2.—Sketch of shrouded valve.

these tests, the apparatus was used in conjunction with a schlieren optical arrangement (reference 9), by which slight differences in index of refraction can be made visible or photographed. The spark arrangement used gave 13 sparks at a rate of about 1,000 per second.

The optical arrangement for taking the schlieren pictures is shown diagrammatically in figure 4, and a

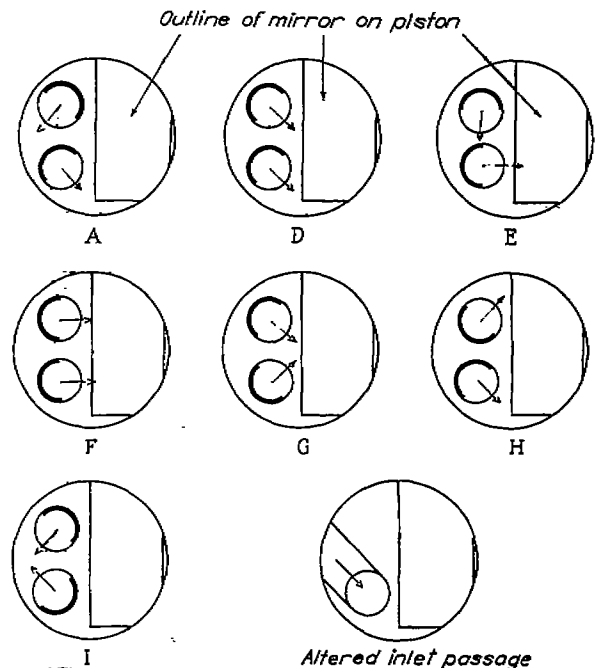

FIGURE 3.—Valve arrangements used.

The variation of pressure in the engine cylinder during intake was determined by means of a Farnboro indicator.

The air quantity was estimated, assuming that, at the time the valves closed, the air temperature in the cylinder had reached a value midway between the inlet temperature and the engine-coolant temperature. The air pressure in the cylinder at that time was atmospheric. The fuel quantity was determined by catching single injections in a vial filled with cotton and weighing the container on a chemical balance.

The fuel used throughout the tests was C. F. R. S-1 reference fuel, having an octane rating of 100 without the addition of tetraethyl lead and containing between

The more important effects noticeable in the results are the differences in burning speeds and the differences in cycle reproducibility with different valve-shroud settings. When the shrouds were set to cause tangential swirl, the burning area was noticeably displaced in the direction of the swirl.

As an aid in the interpretation of the schlieren photographs, a brief description will be given of a typical example taken at 500 r. p. m. (See record 152, fig. 5 (a).) With the type of schlieren arrangement used, the combustion appears darker than the field. The front edge of the combustion region is very sharply defined, and the line of demarcation between the burning region and the burned region is also definite but irregular.

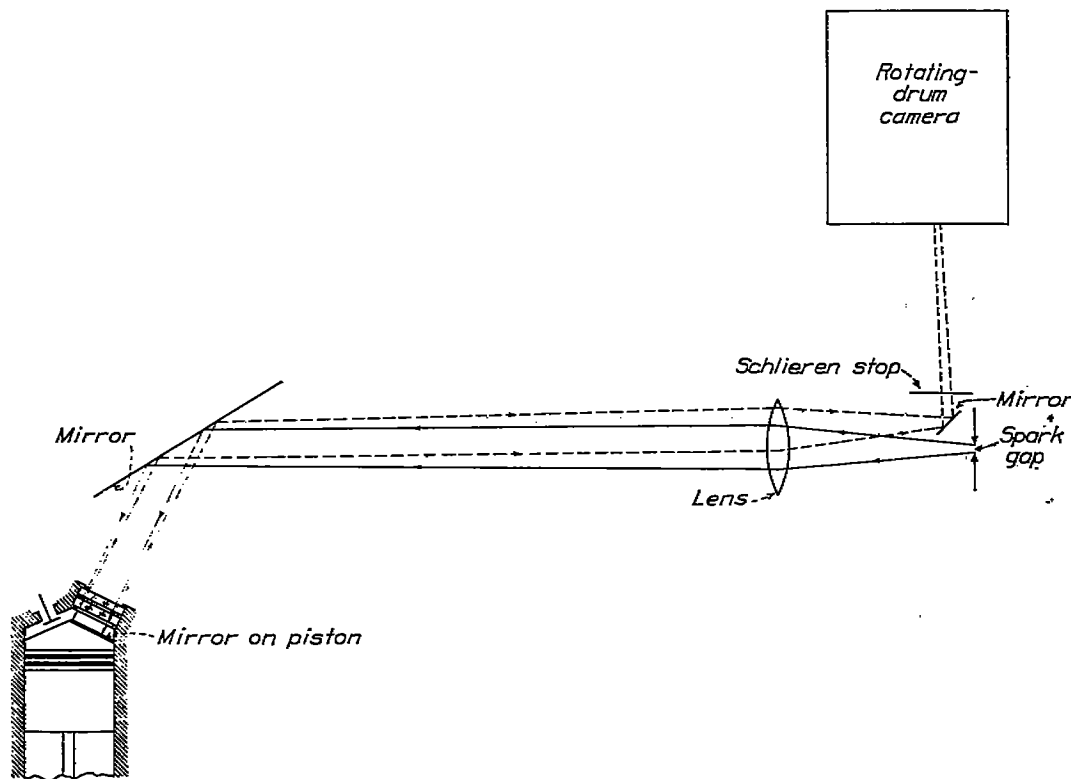

FIGURE 4.—Diagram of schlieren set-up.

90 and 100 percent iso-octane (2, 2, 4 trimethyl pentane).

Constant engine conditions for the tests were as follows:

Compression ratio.....	7.0.
Engine-coolant temperature.....	250° F.
Air-fuel ratio.....	14.
Spark advance.....	30° B. T. C.
Spark-plug location.....	E and F (fig. 1).
Fuel-injection start.....	20° A. T. C. on intake stroke.

RESULTS

Throughout this report, whenever reference is made to the type of air flow induced by a particular shroud arrangement, the description of the air movement was obtained from reference 4, where the air movements generated by each valve arrangement are described in detail.

In the first frame on the left, the start of combustion can be seen just below the record number. In the third frame from the left, the burning from the other spark plug is visible at the lower edge of the picture. (The burning appears at the lower edge later than at the upper edge because it is not visible until it reaches the edge of the mirror which, because of structural requirements, does not cover a half-inch space at that side of the piston.) The burning regions grow until the two fronts meet in the eighth frame, where the clear spaces indicating the burned portion of the charge (first visible in the sixth frame) are plainly visible behind the burning regions. The area of burning then decreases until the last frame shows the burning apparently completed except for traces at the right-hand edge.

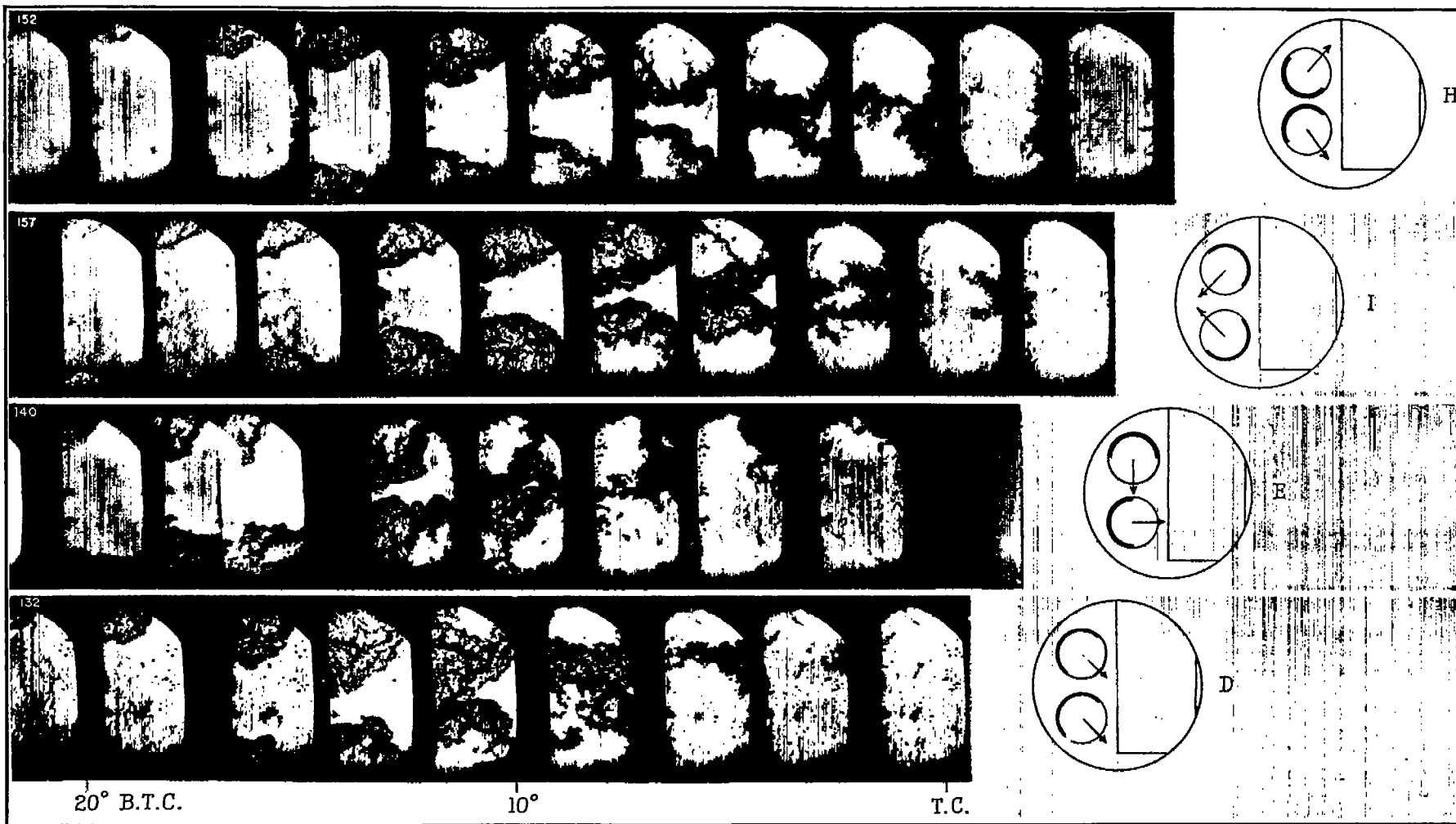

(a) Arrangements H, I, E, and D.

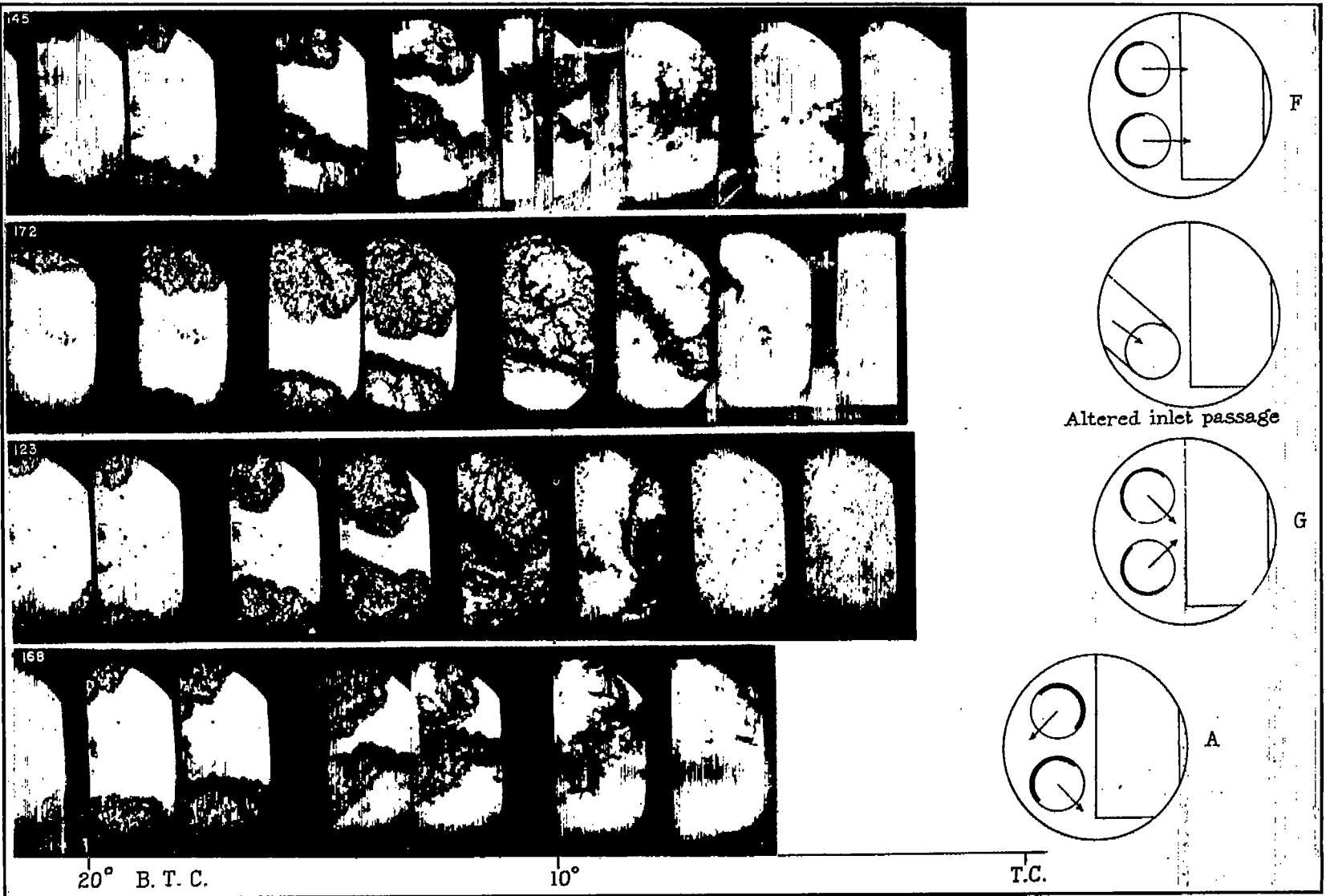

(b) Arrangements F, altered inlet passage, G, and A.

FIGURE 5.—Effect of gas movement on combustion. Engine speed, 500 r. p. m.; two spark plugs.

In figure 5, spark schlieren photographs of the combustion are shown for the eight different air-flow conditions shown in figure 3. The photographs are arranged in order of burning speeds with the setting giving the slowest burning at the top of figure 5 (a). In each case, at least three records were taken for each condition and the record reproduced was chosen as representative.

The approximate burning times as determined by inspection of the photographs are given in the following table. For comparison, the burning time for plain valves has been included.

TABLE I
BURNING TIMES OF RECORDS SHOWN IN FIGURE 5

Valve arrangement	Record	Burning time (crankshaft deg.)	Burning time (sec.)
Plain ¹	272	35.0	0.0117
H.....	152	32.0	.01067
I.....	157	31.5	.0105
E.....	140	29.5	.00888
D.....	132	29.0	.00867
F.....	145	28.5	.0085
Altered inlet passage.....	172	28.0	.00833
G.....	123	27.5	.00817
A.....	168	27.5	.00817

¹ See fig. 8.

In figure 5 (a), record 152 shows the burning with the valves set at arrangement H. The burning in this case was slow although the induced indiscriminate turbulence was high. The general air movement was a vertical-loop motion and could not be detected in the plane of the photographs.

Record 157, for arrangement I, also shows slow burning. The general air movement was a vertical loop, moving in the opposite direction from that given by arrangement H, and the indiscriminate turbulence was very high.

Record 140, for arrangement E, shows clearly the displacement of the burning region caused by the rotary air movement. Although the rotary movement during intake was not so rapid as for some of the other arrangements, the rate at the end of the compression stroke was nearly the same as that of all the other arrangements giving tangential swirls. This result is true also of arrangement D, record 132, which also shows the effect of the swirl. The swirl given by arrangement D had a predominantly vertical component during intake but, on the compression stroke, the vertical component was damped out and only the tangential component persisted.

All the four arrangements in figure 5 (b) show burning rates of somewhere near the same values. The rate appears slightly slower for record 145, arrangement F, although the air motion, a vertical loop at fairly high velocity, would be expected to give good mixing, particularly as the air is directed at the injection valve (fig. 1).

Record 172 shows the burning when one valve was blocked and the inlet passage was faired to give the air

a tangential entry. In his air-swirl tests, Lee found that this arrangement gave a swirl with the axis inclined at about 45°. In these combustion tests, however, the fairing could not be done in the same manner as in Lee's tests, and it is probable that the vertical component of the motion predominated. The photographs show no evidence of a tangential swirl from the single inlet valve.

Record 123, for arrangement G, shows very rapid burning. The burning in this case, however, was rather erratic. Lee found that the vertical-loop motions were damped by 40° A. T. C. on the expansion stroke, but apparently there was some tendency in this case for the burning region to be carried to the side of the chamber nearest the injection valve.

Record 168, for arrangement A, again shows the influence of the axial swirl. In this case, the high swirl rate during intake undoubtedly aided the mixing, and the swirl persisted through the compression stroke and carried the burning region with it. The burning was very rapid and uniformly reproducible.

Figure 6 shows records taken with one spark plug for four of the arrangements included in figure 5, the photographs being arranged in the same order. The slow burning given by arrangement H is again evident in record 150, where all 13 of the available spark discharges were required to record the complete history of the burning.

Record 138 appears to be somewhat out of step with respect to burning speed, although this apparent discrepancy may be due to the fact that the rotary air movement swept the burning region out of sight. Records 143 and 161 show very nearly the same burning speeds.

When only one spark plug is used, the displacement of the burning region by the air movement cannot be separated from increase or decrease in the speed of combustion travel. The actual rate of combustion travel may possibly have been greater in record 143 than it was in record 161; the burning region in record 161 may have been carried around by the rotary air movement and the burning completed in the rear part of the chamber outside the field of view.

Figure 7 shows two records with shrouded valves and a record of the burning with the altered inlet passage; the records were made at an engine speed of 1,000 r. p. m. and with two spark plugs. Record 185, arrangement H, again shows the slowest burning speed, with no indication of displacement by air movement. Record 178, with the altered inlet passage, shows the highest rate of burning of the three arrangements. The rate of air flow through the single valve must necessarily have been high at 1,000 r. p. m. and some residual vertical-loop motion probably remained at the end of the compression stroke. In record 179, the rotary air movement is again made apparent by the displacement of the burning region.

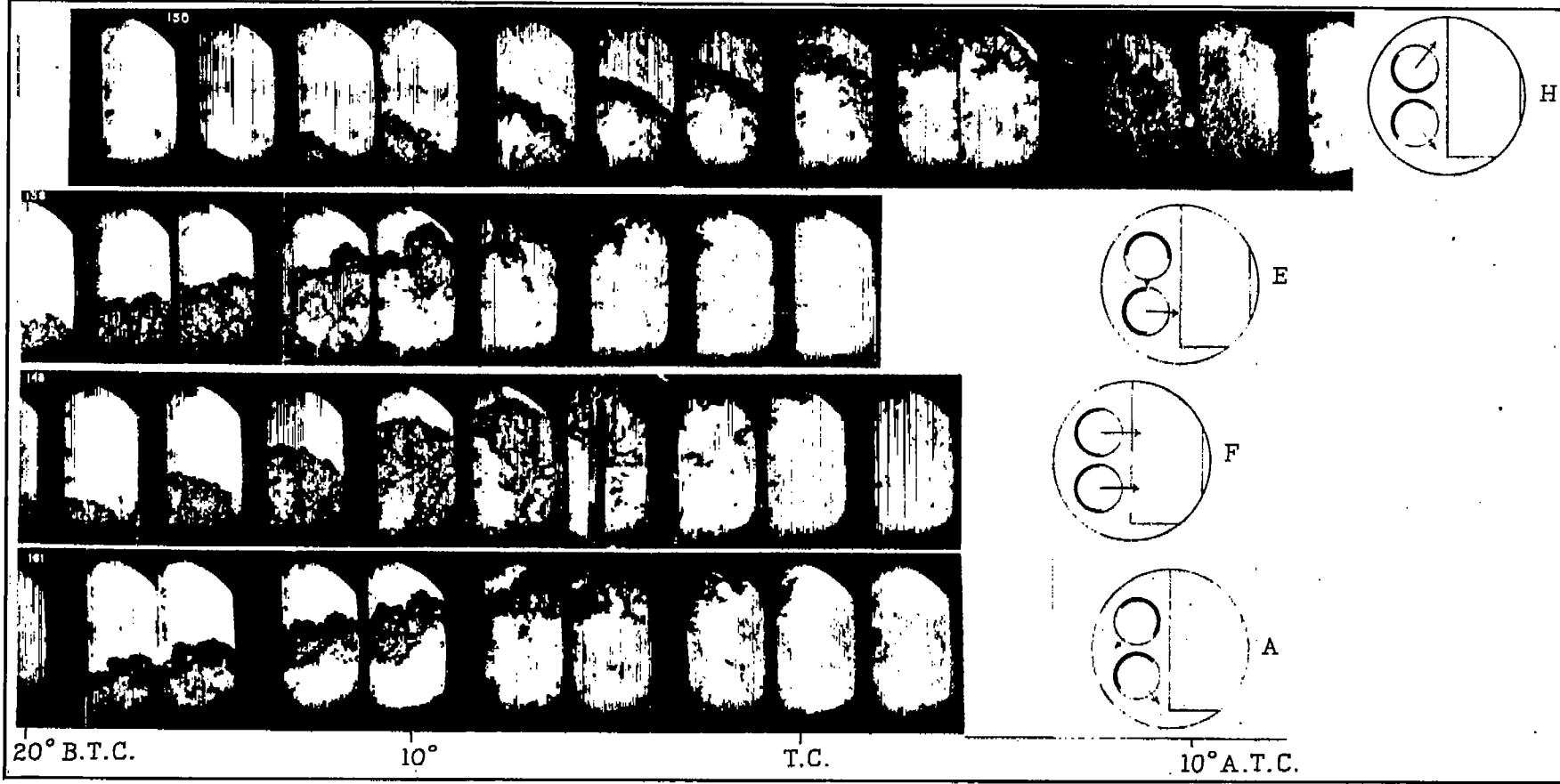

FIGURE 6.—Effect of gas movement on combustion. Engine speed, 500 r. p. m.; one spark plug.

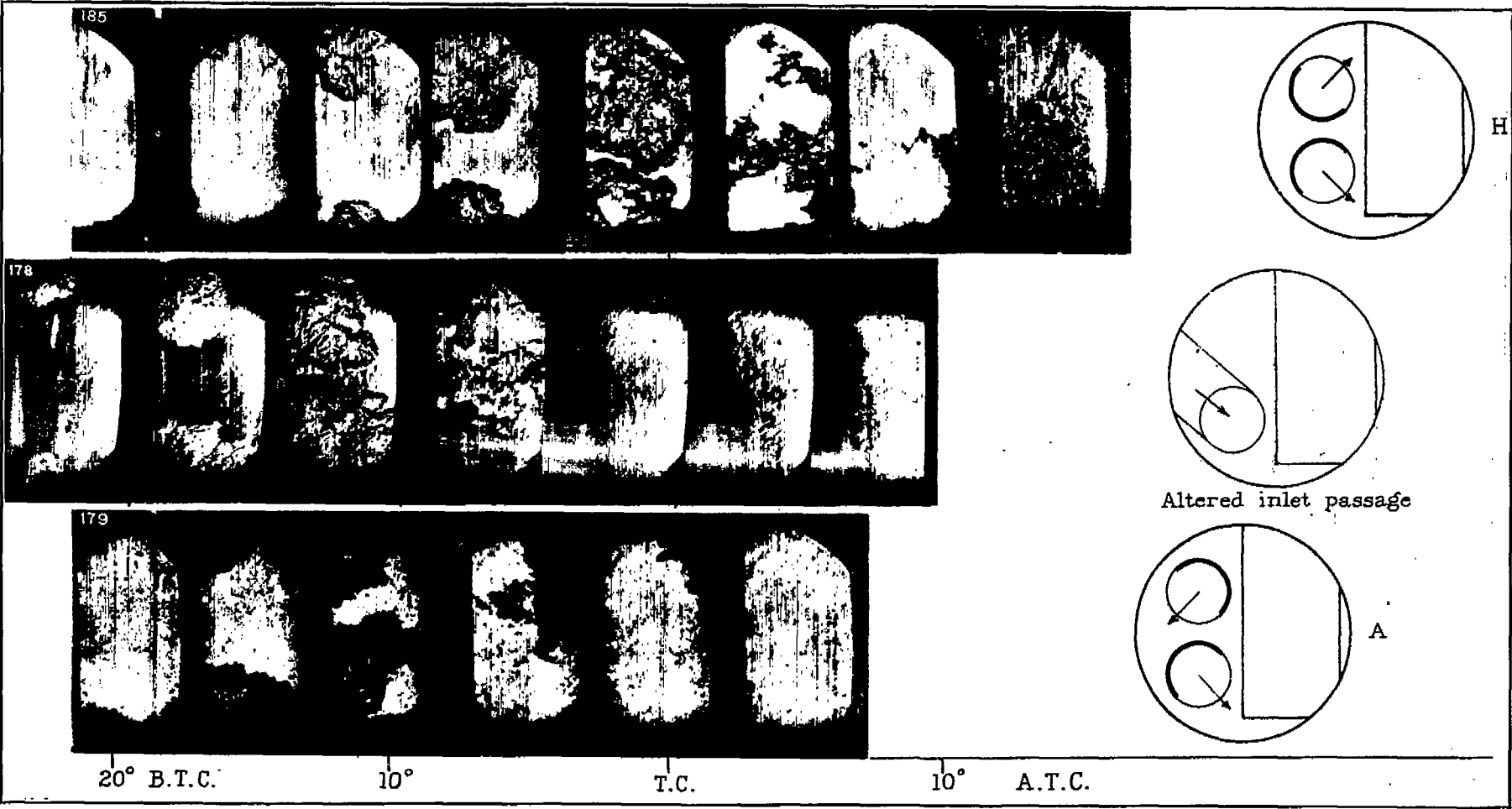

FIGURE 7.—Effect of gas movement on combustion. Engine speed, 1,000 r. p. m.; two spark plugs.

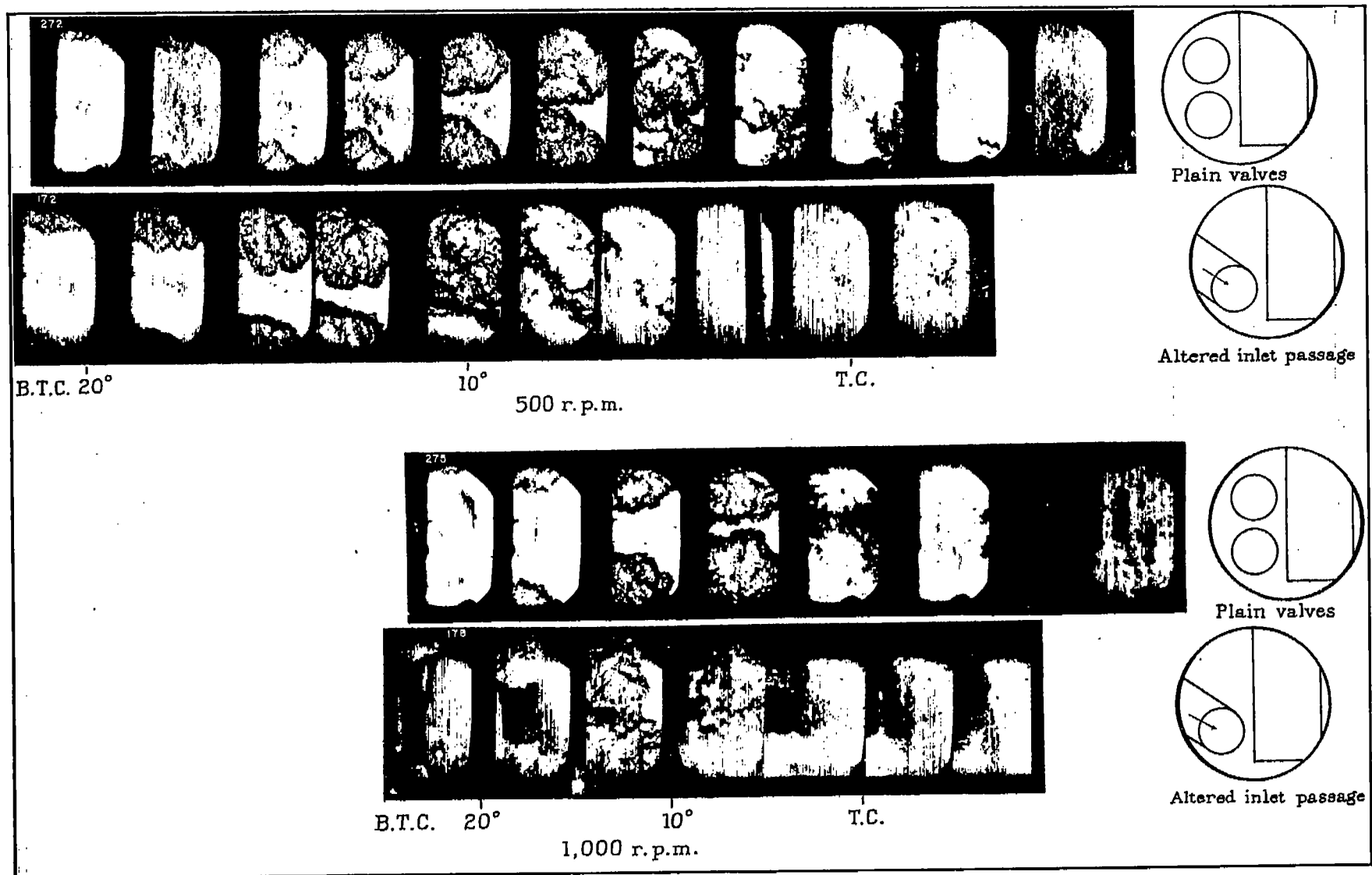

FIGURE 8.—Effects of engine speed and inlet-air velocity on combustion. Two spark plugs; spark advance, 30°.

Photographs of the burning at 500 and 1,000 r. p. m., when two plain valves were used and when one valve was blocked and the intake passage was faired, are shown in figure 8. The Farnboro indicator records for an engine speed of 500 r. p. m. with one and with two valves and for a speed of 1,000 r. p. m. with two valves show that the pressure remained very nearly atmospheric throughout the intake stroke. At 1,000 r. p. m. with one valve, a pressure difference of about 2.4 inches of mercury existed through part of the inlet stroke. On the basis of this evidence, it is assumed that the inlet-air velocity at 500 r. p. m., and at 1,000 r. p. m. with two valves, varies directly as the piston speed and inversely as the flow area. At 1,000 r. p. m. with one valve, the velocity probably reached a value from 10 to 25 percent greater (depending on the coefficient of discharge of the valve) than it would have reached if the velocity had remained a linear function of piston speed and flow area. The two groups of photographs, if taken separately, show the burning when the engine speed was kept constant and the inlet-air velocity was approximately doubled. A comparison between record 172 for one valve at 500 r. p. m. and record 275 for two valves at 1,000 r. p. m. represents the condition in which the linear velocity of the inlet air remains approximately constant (although the rates of mass flow differed) while the engine speed is doubled.

Inspection of figure 8 shows that increasing the engine speed without changing the linear air speed caused a large increase in burning speed. Increasing the inlet-air velocity without changing the engine speed also caused a definite increase in the burning speed, as shown by the comparison of the records given in figure 8 and in the following table.

TABLE II

VARIATION OF BURNING TIMES WITH INLET-AIR VELOCITY AND ENGINE SPEED

Record	Engine speed (r. p. m.)	Number of valves	Burning time (crankshaft deg.)	Burning time (sec.)
272	500	2	35	0.0117
172	500	1	25	.0088
275	1,000	2	35	.0058
178	1,000	1	25	.0042

A comparison of records 272, 172, and 275 shows that the proportional increase in burning speed obtained by increasing the engine speed and maintaining the inlet-air velocity approximately constant is about the same as that obtained by increasing the inlet-air velocity. Record 172 shows a burning time 0.71 that of record 272; and record 275, a burning time 0.70 that of record 172. Comparison of the records of figure 8 on the basis of engine speed shows that the burning speed increased

linearly with engine speed when either one or two valves were used. (Compare records 272 and 275 and records 172 and 178.)

The indicator-card records in figures 9, 10, and 11 show the cylinder pressures under the various air-flow conditions tested at different speeds and with one and two spark plugs. Each record shown is a composite of 10 or more indicator cards. The composites were obtained by superimposing the negatives for the indicator cards and printing them simultaneously. In cases where the individual lines were too faint to reproduce readily when the composites were rephotographed, they were retouched. Usually some of the lines were exactly superimposed, so that one line showing in the print may correspond to several records. Some striking differences in reproducibility are at once apparent.

Arrangement I is omitted because of the general similarity of its results to those obtained with arrangement H, and a composite of cards taken with plain valves is substituted. Considerable spread is shown in records 316-325, for plain valves. Peak pressure was attained at or slightly before top center. The occasional light knock does not show in the composite print because of the overlapping of the lines. Records 240-250 for arrangement H also show considerable spread, and about half of the records show knock. Peak pressure was reached at approximately top center. The remaining six groups of records were nonknocking. A striking improvement in reproducibility is noted in the group of records 222-231, for arrangement E. Records 262-271, for arrangement D, again show some spread, as do the groups 149-158 and 242-251, for the faired inlet passage and for arrangement F, respectively. Records 212-221, for arrangement G, show the highest rates of pressure rise of any of the records, but successive cycles were erratic. The best reproducibility of all was shown by records 252-261, for arrangement A. Although there is little difference in the composite of records 222-231 and that of records 252-261, records 222-231 showed slight individual differences not apparent in records 252-261.

Figure 10 is a comparison of the reproducibility at the two extreme conditions of valve-shroud settings (arrangements H and A) with only one spark plug. The change in reproducibility is very evident although perfect reproducibility was not attained with one plug, even with the most favorable air-flow conditions. Records 214-224 do not show any knock, whereas records 228-237 do.

Figure 11 compares the reproducibility of the indicator cards taken at 1,000 r. p. m. with plain valves and with shrouded valves set for full tangential swirl (arrangement A.) The reproducibility shown by records 119-128 is very striking. Any two individual cards can be superimposed as though they were stamped by a single die.

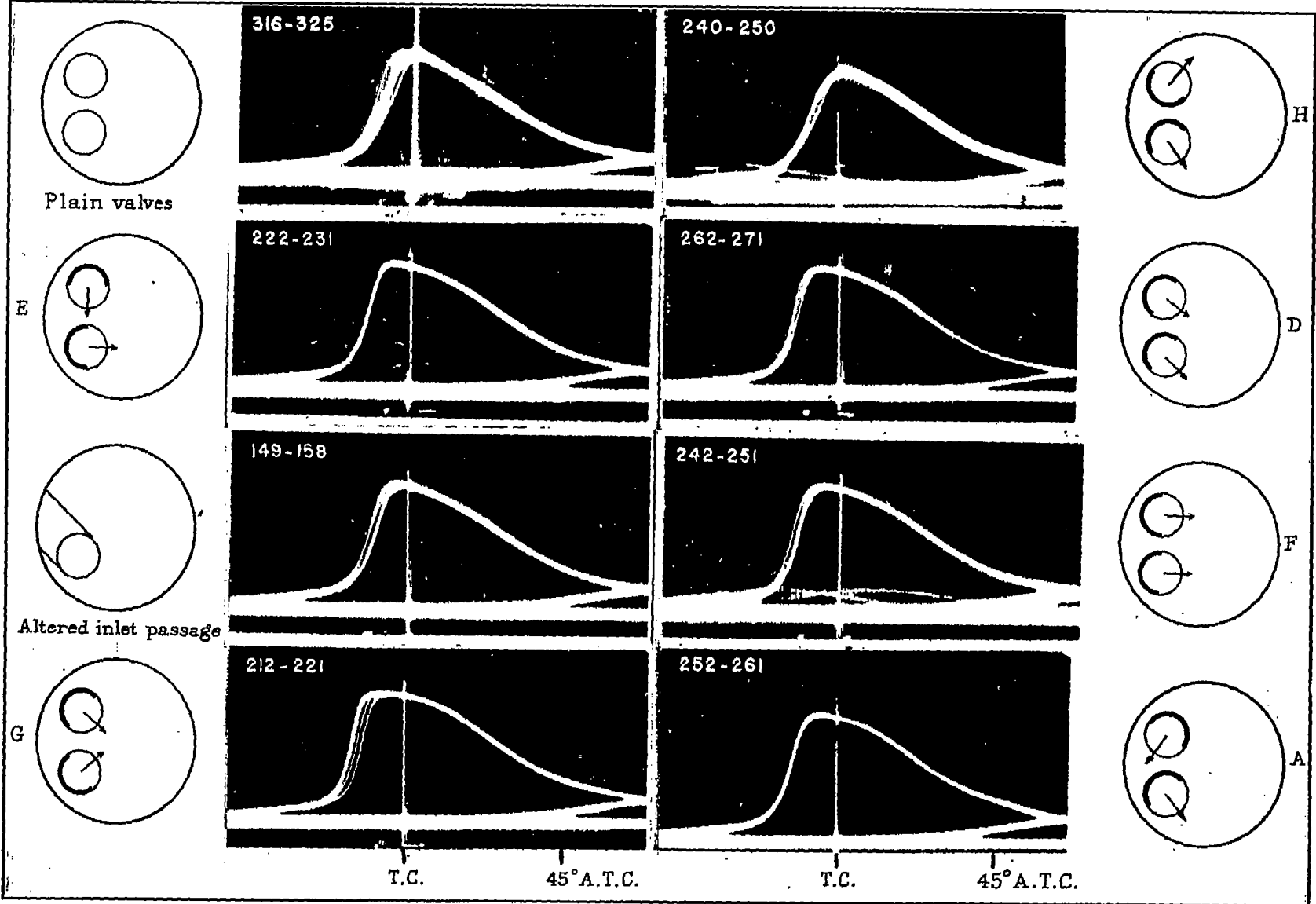

FIGURE 9.—Effect of gas movement on cycle reproducibility. Engine speed, 600 r. p. m.; two spark plugs.

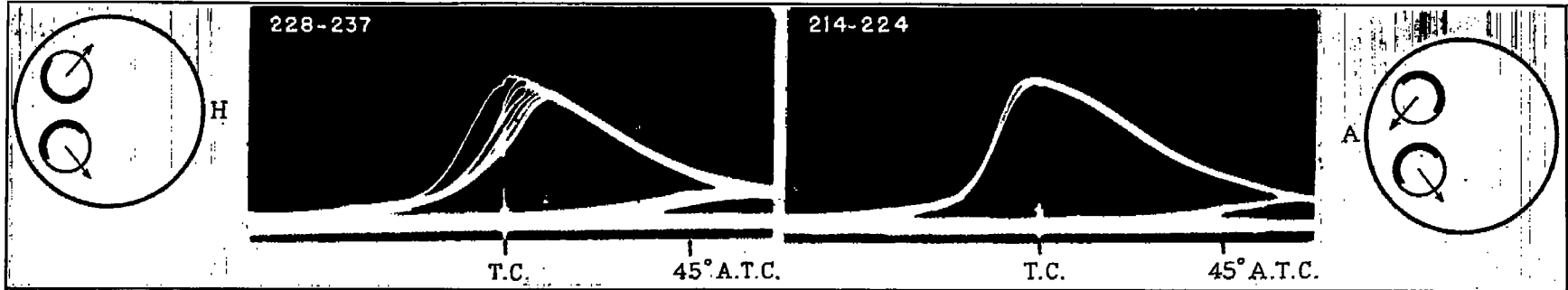

FIGURE 10.—Effect of gas movement on cycle reproducibility. Engine speed, 600 r. p. m.; one spark plug.

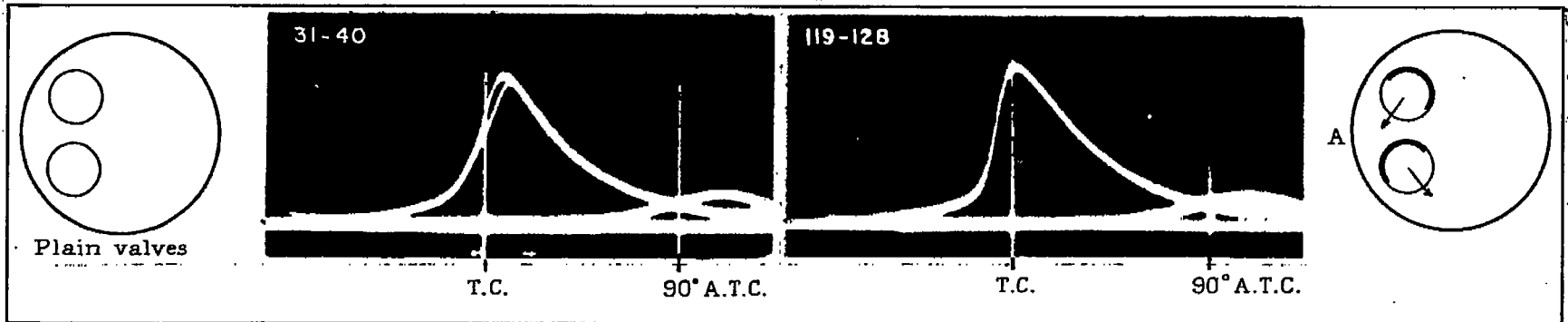

FIGURE 11.—Comparison of effects on cycle reproducibility of plain valves and of shrouded valves set for full axial swirl. Engine speed, 1,000 r. p. m.; two spark plugs.

DISCUSSION

In the analysis of the data presented in this report, no attempt has been made to determine the actual mechanism by which the final effects of air flow on combustion were attained. It is difficult to determine whether some of the effects are caused by improved mixing of the charge, by increase in turbulence during combustion, or by other factors.

The most evident effects in this series of tests were the changes in burning speed and the differences in the reproducibility of the indicator cards from cycle to cycle.

BURNING SPEEDS

It is well known that the flame speed increases almost linearly with engine speed. This increase in flame speed is usually attributed to the increased turbulence of the charge, caused by the higher inlet-air velocities accompanying the higher engine speed. Marvin and Best, using gaseous fuel well mixed before entering the cylinder, attributed the increase in flame speed with engine speed to increased turbulence (reference 10). David (reference 11) found that turbulence induced by a fan in a bomb increased the flame speed. Schnauffer (reference 12) attributed variations in measured flame speeds to variations in turbulence and investigated the effects of turbulence by varying the engine speed. Bouchard and his co-workers (reference 13) report an investigation of different variables affecting flame speed in which it was found that the speed varied almost linearly with engine speed. They attribute the increase in maximum rate of combustion with increased engine speed to an increase in small-scale turbulence resulting from higher gas velocities through the inlet system.

In all the available literature relating to the variation of combustion speed with engine speed, the changes have been attributed to changes in turbulence because of the known effects of turbulence on combustion in bombs and probably because no other logical explanation has been readily available. So far as is known, no attempt has been made by investigators to separate the effects of the gas velocities in the inlet system from the effects of the time interval elapsing between mixing and ignition. Such a separation of the two effects has been partly done in the data shown in figure 8, and the indicator cards in figures 9 and 11 can be used for similar comparisons.

The results shown in table II may indicate that the increased burning rate accompanying an increase in engine speed is caused equally by the increased turbulence and by the decreased time interval. Previous work at this laboratory has given evidence that the time interval between the mixing of the fuel and the air and the occurrence of ignition may influence the rate of combustion. In tests of fuel injection and spark ignition of various fuels in the N. A. C. A. combustion apparatus, Rothrock and Cohn (reference 14)

found that, as the injection advance angle was increased (above a certain minimum), the rate of combustion decreased. In compression-ignition tests, Rothrock and Waldron (reference 6) found that, as the injection advance angle was increased, the rate of combustion first increased until a limiting value of advance angle was reached and then decreased with further increase in advance angle. Cohn and Spencer (reference 15), studying the combustion of fuels injected into a bomb and ignited by a spark, found the rate of combustion to decrease as the time interval between injection and ignition increased. The intervals between injection and ignition were comparable with those occurring in an engine.

It may be suggested that the turbulence induced by the inlet air might have been damped out by the end of compression at 500 r. p. m., whereas the damping was not so great at 1,000 r. p. m. Direct examination of Lee's photographs (reference 4) for these conditions shows, however, that the turbulence was about the same for 500 r. p. m. and one valve as it was for 1,000 r. p. m. and two valves. The measured swirl velocities for the two conditions show about the same velocities persisting during the compression stroke.

A comparison of record 272 (fig. 8) with records 152 and 157 (fig. 5 (a)) indicates that doubling the inlet-air velocity by shrouding half of each inlet valve does not necessarily increase the burning speed to any great extent.

MIXING EFFECTS

One definite effect of the directed air flow may be observed by a study of the photographs of figures 5, 6, and 7. It will be seen that the rate of combustion was increased whenever the inlet air was directed in such a manner as to be carried past the injection valve in an orderly fashion during injection, as in arrangements A, F, and G; in the altered inlet passage with one valve; and, to a lesser extent, in arrangements D and E. According to the tests reported in reference 4, the swirl velocity during inlet was lower for arrangements D and E than it was for the other four arrangements. It is believed that the effect of the orderly swirl in increasing the combustion rate is attributable to the improvement in mixing.

REPRODUCIBILITY

It is generally known that successive cycles of a spark-ignition engine vary widely in rates of pressure rise and in total pressures. Different causes have been suggested, among them being: Variations in spark timing, in amount of charge per cycle, in mixture strength, and in quantity of oil that gets past the piston rings. It has been suggested that the distillation range of the fuel might influence the reproducibility. Attempts toward improvement have included the use of several spark plugs. Both fuel-injection spark-

ignition engines and carburetor engines have been found to be affected to the same extent.

In all probability, several factors enter into the problem. Obviously the spark timing must be uniform and the mixture strength and the amount of charge must be constant, or there will be variation.

Even though the foregoing conditions are controlled, variations in successive cycles will occur, as has been determined by engine tests. The indicator cards of figures 9, 10, and 11 show that the variation can be controlled by properly directing the air movement, provided that the other factors (spark timing, mixture strength, and amount of charge per cycle) are properly controlled. The tests with valve arrangement A, in particular, have been repeated several times. On one occasion, because of failure of the glass mirror on the piston, the engine was torn down, new valves and shrouds were installed, and the engine was reassembled. Results after the overhaul were fully as consistent as before. After those tests, a new piston was installed in the engine, having a crown such as that shown in figure 1 instead of the V-shaped crown used when the schlieren photographs were taken. The engine was then somewhat more sensitive to slight changes in the valve-shroud settings, and some experimentation was usually necessary to attain as good results as before. When the proper valve-shroud settings were used, however, the results were quite reproducible. Out of 50 or 60 records taken with valve arrangement A (or approximately that setting) and two spark plugs, only two or three records have shown any appreciable variation and those variations were traced to such causes as variations in mixture strength.

It will be noted, in an examination of figure 9, that arrangements A, D, and E, which gave an axial type of swirl, also showed the best reproducibility. For arrangement D, the improvement was only slightly greater than that shown by some of the other settings. Arrangement D tended to give a vertical-loop motion during the early part of the inlet stroke, which may or may not have influenced the reproducibility. Apparently a swirl that moved the charge past the spark plugs while the spark was occurring was of most value in improving the reproducibility.

In application to actual engine use, it is probable that experimental results are necessary to determine the type of air swirl best suited to the particular design of combustion chamber and location of spark plugs.

CONCLUSIONS

1. Excellent cyclic reproducibility was obtained by directing the air so that the swirl moved past the spark plug and was in a plane normal to the axis of the cylinder.

2. Doubling the engine speed without increasing the linear velocity of the inlet air caused an increase in the

rate of combustion of the same magnitude as that caused by doubling the inlet-air velocity without increasing the engine speed.

3. When the valves were shrouded so that the inlet-air velocity was doubled and were set to cause a directed air swirl, the rate of burning was increased.

4. When the valves were shrouded so that the inlet-air velocity was doubled but were set so that there was no directed swirl, the rate of burning was not necessarily increased.

LANGLEY MEMORIAL AERONAUTICAL LABORATORY,
NATIONAL ADVISORY COMMITTEE FOR AERONAUTICS,
LANGLEY FIELD, VA., October 10, 1938.

REFERENCES

1. Rothrock, A. M.: Effect of High Air Velocities on the Distribution and Penetration of a Fuel Spray. T. N. No. 376, N. A. C. A., 1931.
2. Rothrock, A. M., and Spencer, R. C.: Effect of Moderate Air Flow on the Distribution of Fuel Sprays after Injection Cut-Off. T. R. No. 483, N. A. C. A., 1934.
3. Rothrock, A. M., and Waldron, C. D.: Fuel Spray and Flame Formation in a Compression-Ignition Engine Employing Air Flow. T. R. No. 588, N. A. C. A., 1937.
4. Lee, Dana W.: A Study of Air Flow in an Engine Cylinder. T. R. No. 653, N. A. C. A., 1939.
5. Rothrock, A. M., and Spencer, R. C.: A Photographic Study of Combustion and Knock in a Spark-Ignition Engine. T. R. No. 622, N. A. C. A., 1938.
6. Rothrock, A. M., and Waldron, C. D.: Some Effects of Injection Advance Angle, Engine-Jacket Temperature, and Speed on Combustion in a Compression-Ignition Engine. T. R. No. 525, N. A. C. A., 1935.
7. Beardsley, Edward G.: The N. A. C. A. Photographic Apparatus for Studying Fuel Sprays from Oil Engine Injection Valves and Test Results from Several Researches. T. R. No. 274, N. A. C. A., 1927.
8. Tozier, Robert E.: The N. A. C. A. Optical Engine Indicator. T. N. No. 634, N. A. C. A., 1938.
9. Taylor, H. G., and Waldram, J. M.: Improvements in the Schlieren Method. Jour. Sci. Inst., vol. 10, no. 12, Dec. 1933, pp. 378-389.
10. Marvin, Charles F., Jr., and Best, Robert D.: Flame Movement and Pressure Development in an Engine Cylinder. T. R. No. 399, N. A. C. A., 1931.
11. David, W. T.: Turbulence in Internal Combustion Engines. The Engineer, vol. CXLIV, no. 3755, Dec. 31, 1937, pp. 733-734.
12. Schnauffer, Kurt: Combustion Velocity of Benzine-Benzol-Air Mixtures in High-Speed Internal-Combustion Engines. T. M. No. 668, N. A. C. A., 1932.
13. Bouchard, C. L., Taylor, C. Fayette, and Taylor, E. S.: Variables Affecting Flame Speed in the Otto-Cycle Engine. S. A. E. Jour., vol. 41, no. 5, Nov. 1937, pp. 514-520.
14. Rothrock, A. M., and Cohn, Mildred: Some Factors Affecting Combustion in an Internal-Combustion Engine. T. R. No. 512, N. A. C. A., 1934.
15. Cohn, Mildred, and Spencer, Robert C.: Combustion in a Bomb with a Fuel-Injection System. T. R. No. 544, N. A. C. A., 1935.